



HEAR BEAUTY.
SEE BEAUTY.
HIDE EVERYTHING ELSE.



ENGLISH

HEAR BEAUTY. SEE BEAUTY.

It is no surprise that both design and hifi enthusiasts love clic.

The idea of a luxurious and functional furniture that hides where it needs to and still present sound in a stylish way, arose when Mike Fabricius was unable to find a furniture that was both functional and had a great design at the same time.

With more than 3000 vinyl records on the shelf and a large hifi system combined with a high demand for both sound and the visual result, he had no choice but design a furniture himself.

The result was clic.

clic is a well thought out combination of hifi and exclusive Danish furniture design. The furniture allows you to hide cables, speakers, subwoofers, gaming consoles, projectors and everything else that disturbs the eye – and make it a part of a stylish setup – without compromising the great sound and design.

HIDE EVERYTHING ELSE...



Model 110, 110, 140S Right

CONTENTS

NEWS	PAGE 4
FABRIC DOORS & FINISH	PAGE 6
HIFI EXPERT	PAGE 7
FUNCTIONS	PAGE 8
DESIGN FREAK.....	PAGE 10
MOUNTING	PAGE 12
VINYL LOVER	PAGE 15
MOVIE FAN.....	PAGE 16
REMEMBER WHEN ORDERING	PAGE 17
CLIC DEPTH 26,5 CM	PAGE 18
CLIC DEPTH 37,5 CM	PAGE 20
CLIC DEPTH 45,5 CM	PAGE 22
CLIC DEPTH 55 CM	PAGE 24
DOORS & DRAWERS	PAGE 26
ACCESSORIES	PAGE 27

NEWS

clíc introduces:

- 27 new models
- New and smaller depth 26,5 cm.
- New furniture width 202 cm.
- 2 new veneer quality's: Oak and walnut
- 5 new fabric door colours in a brand new quality

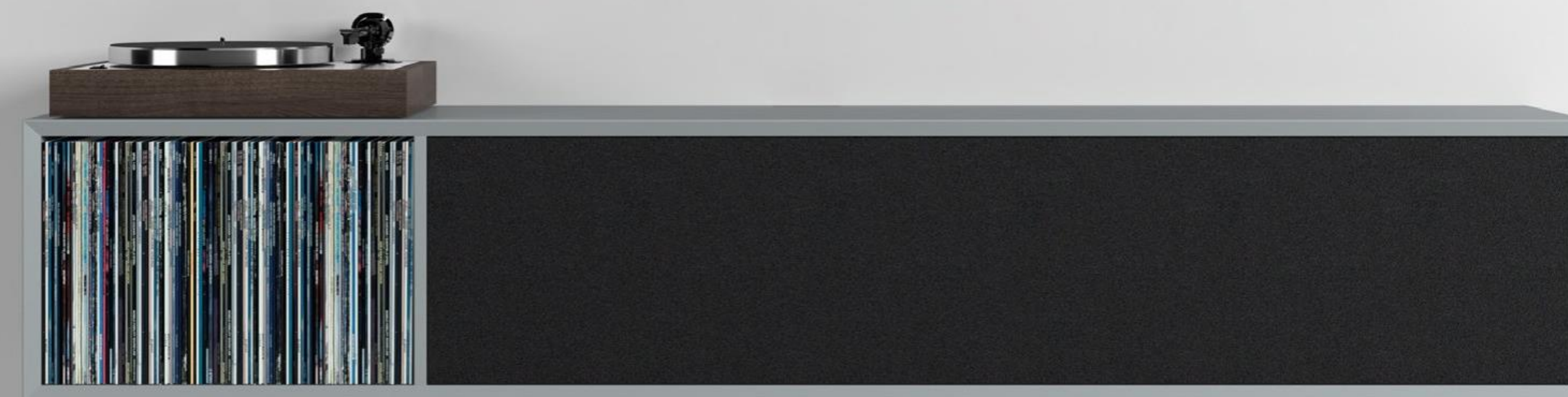

Model 240S Right

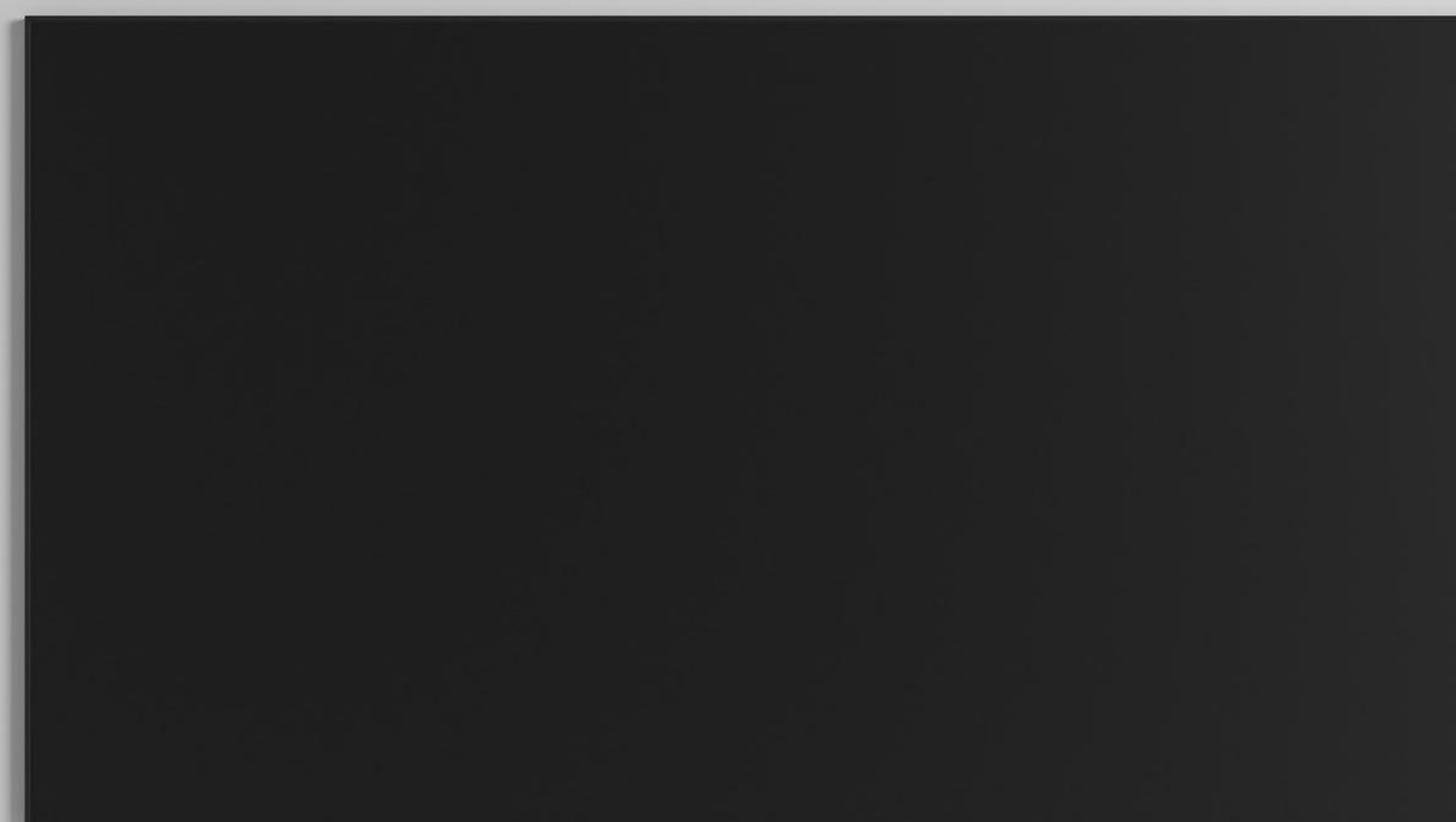

Model 240 Center

202 CENTIMETERS

clic introduces a long line of new models in a brand new width on 202 centimeter. The new models summarize all the knowledge and knowhow clic has gathered during the last 14 years. The models in the new width are available in 2 heights, 4 depths and a number of combinations.

As an example model 240 is available in 5 different variants:

- Model 240
4 rooms, all in the same size
- Model 240 Center
3 rooms, the room in the middle is wider and can as an example store a large center speaker
- Model 240 Large
3 rooms, all in the same size
- Model 240S Left
2 rooms, a small one and a big one. On model Left the big room is on the left side and can be used for a Soundbar or other longer items
- Model 240S Right
2 rooms, a small one and a big one. On model Right the big room is on the right side and can be used for a Soundbar or other longer items

With furniture in the new width, we made it even easier to create an elegant set-up without losing focus on the sound quality and the design.

Besides the 27 new models we also introduce a new and smaller depth on only 26,5 cm. There are 4 new models in this depth and 2 of these are 202 cm. wide.

When using the new model 14S Left in 26,5 cm. you get an elegant furniture setup with room for a small music system without taking up too much space into the room. With a 65-inch screen above the furniture, the furniture will still be wider than the screen, which visually creates a balance.

You can see a complete overview off all clic models in all 4 depths on page 18 to 25.

Alongside the new models clic are also launching 2 new veneer quality's: Oak and walnut. All clic models are available in the new veneers.

We also introduce 5 new fabric door colours in a brand new quality. The 5 new colours compliments our 4 existing paint colours and the new oak and walnut perfectly.



Model 240S Left



Model 240 Large

FLEXIBILITY

Model 240 can be ordered in 5 different variants – they are all shown on these pages in different colours and with different content.



Model 240

FABRIC DOORS IN 16 COLOURS

The clic furniture are available with fabric doors in 16 different colours. The fabric doors allow you to hide speakers and music systems and send signals in and sound from the speakers out – without opening the door.

NEWS: We introduce 5 new fabric colours with a rougher look that gives the final look a bit more edge.



COAL



CONCRETE



FROST



COFFEE



LATTE



DUSTY BLUE



GREY



DARK BLUE



OLIVE GREEN



BROWN



BEIGE



WHITE



SILVER



BLACK



BORDEAUX



RED



Oak veneer



Walnut veneer



White paint

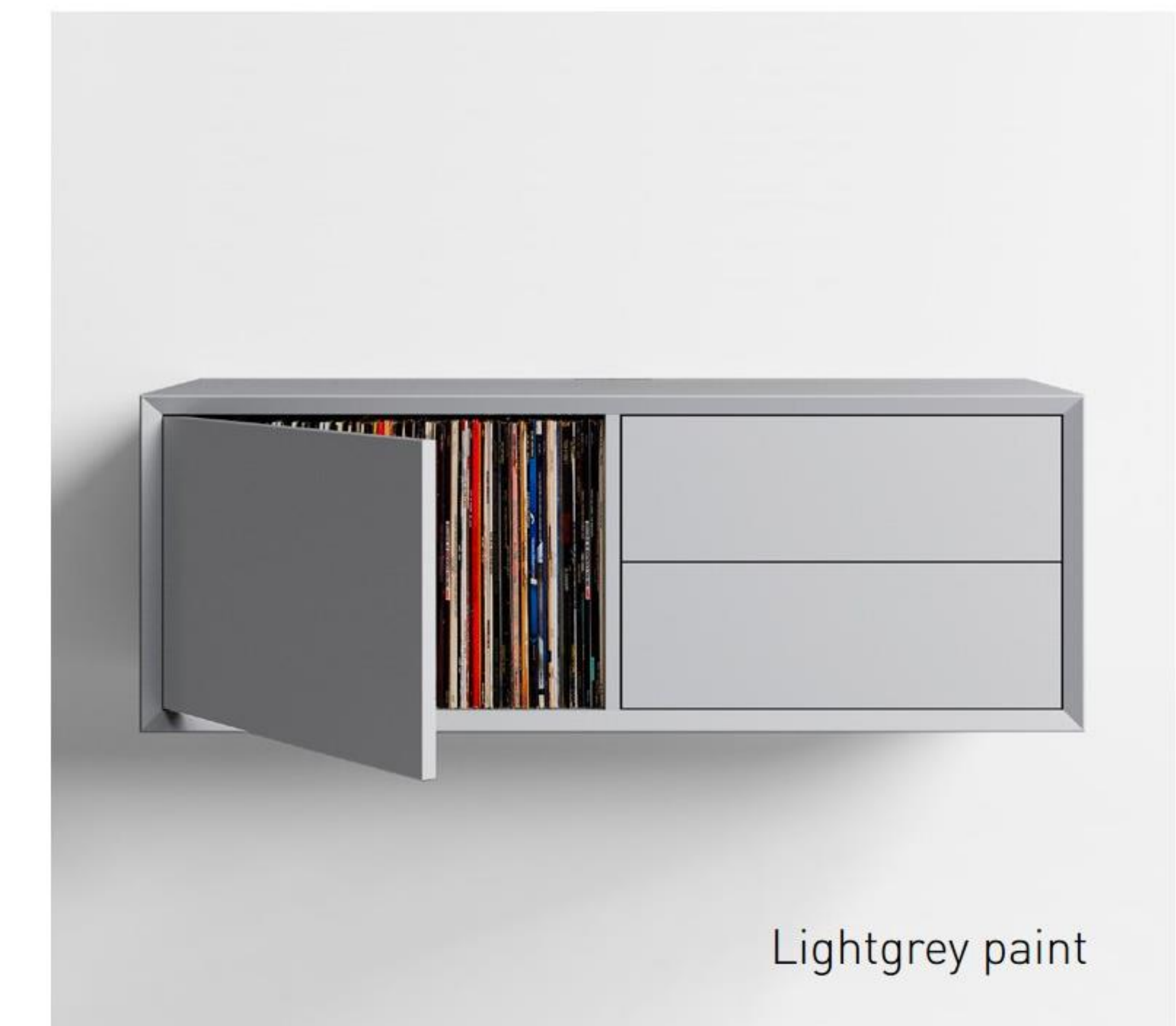

Lightgrey paint

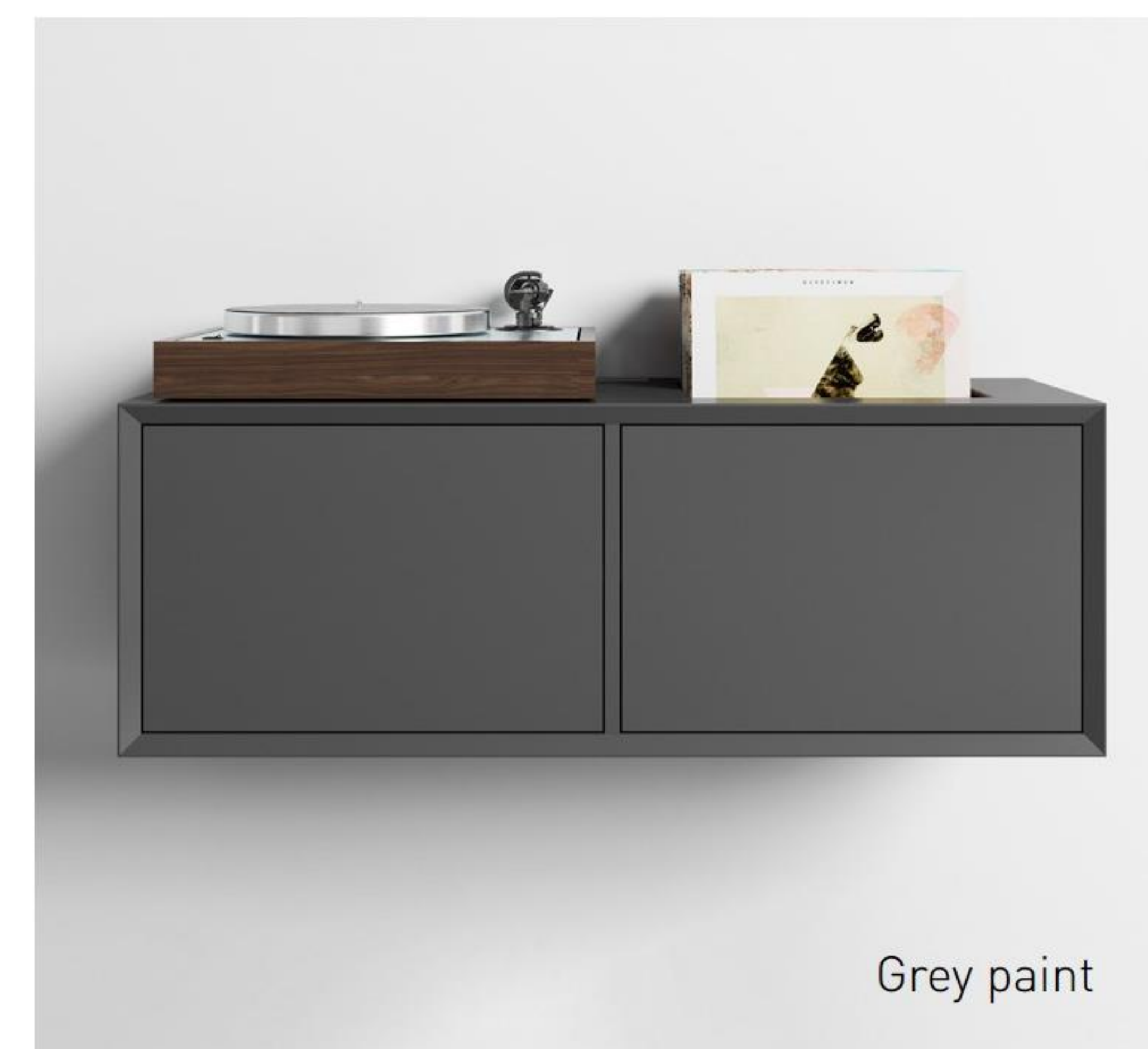

Grey paint

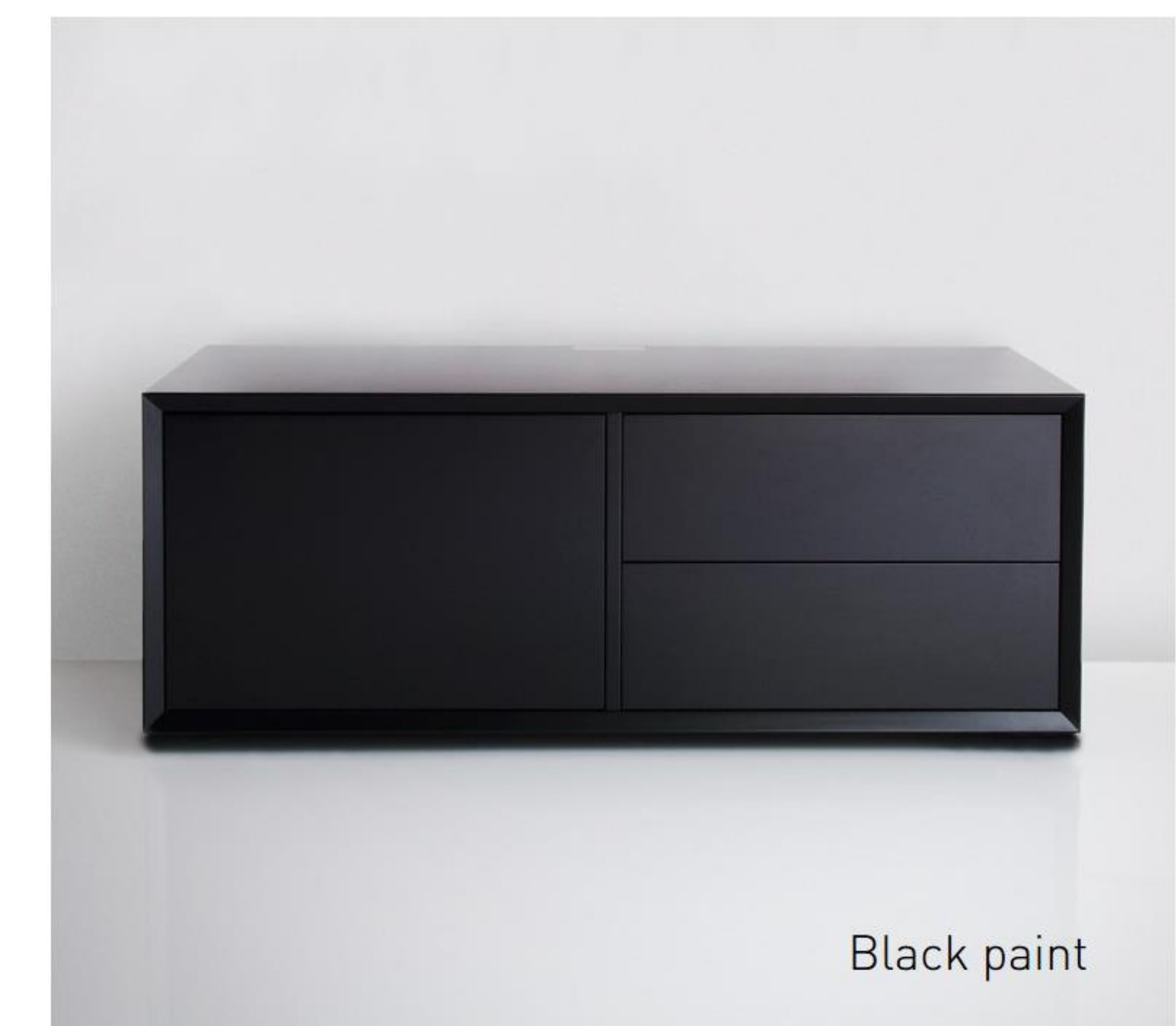

Black paint

FINISH & QUALITY

All clic furniture, wooden doors and drawers are available in white, lightgrey, grey and black paint and the 2 new veneers: Oak and walnut.

Regardless of colour or finish all clic furniture are produced after the same principle with high focus on quality.



Exclusive finish

HIFI EXPERT



FUNCTIONS

A WELL THOUGHT OUT FURNITURE

VINYL HOLE

With a vinyl hole in the top of your furniture, you get a cool and elegant storage solution for your favorite vinyl records.

CHARGER

With a clic charger for iPhone you can store and charge your iPhone directly in the top of the furniture.

VENTILATION

With a clic ventilation you can cool down the items stored behind a wood or fabric door.

FIREPLACE

With a clic fireplace you can integrate the warm and cosy feeling in the top of your clic furniture.



DRAWERS

The drawers in the clic furniture are divided with 2 metal sticks. The metal sticks can be placed in different ways to store all kinds of software or other items.

BACK PLATES

The clic furniture has a 5 cm. advanced magnet mounted back plate. This allows you to hide cables behind it.

FABRIC DOORS

The clic furniture is available with fabric doors allowing you to hide your music or movie system and control it through the fabric doors and allowing the sound to come out - without opening the doors.

ALU COVERS

clic's cable covers are available in 4 different variants. Choose between brass or aluminum in black or silver.

WOOD DOORS

The clic wood doors allow you to hide the items you don't wish to display.



The image shows a modern interior with light-colored wood herringbone flooring and white walls. On the left, a doorway leads to another room with a large window, a wicker chair, and a patterned rug. On the right, a white desk is mounted on the wall, featuring a black office chair, a potted plant, and framed artwork. A thin white line runs vertically through the center of the image, separating the vinyl storage area from the desk area.

VINYL AND BINDER

You can store your vinyl records or binders in several of clic's furniture models, and still use the hidden space in the back of the furniture for cables etc.

WALL BRACKETS

If you want to place your clic furniture on the wall you simply use clic's special designed wall brackets. You can mount your furniture completely up against the wall.

MODEL DESKTOP

clic Desktop has all the same functions integrated as the rest of the clic models. Model Desktop has a table flap that opens down when opened. The top of the flap is aligned with the furniture when opened.

DESIGN FREAK



MADE IN DENMARK

All design, development and production of the clic furniture are based in Denmark and all our furniture are made by hand.

Even the last coat of paint are done by hand to ensure a flawless finish and high quality.

All our materials are sourced in Denmark and we handpick all our subcontractors.

Our demand on materials and quality are constantly in focus. Our functions such as the removable back plates, our wall brackets and cables holes in the top and bottom are thought out down to the smallest detail and is a significant part of clic's dna.

Our furniture are constructed to provide optimal strength and to hold a high amount of weight regardless if you place them on the floor on stands or mount them on the wall. All our furniture undergo a thoroughly quality check before they leave our production.

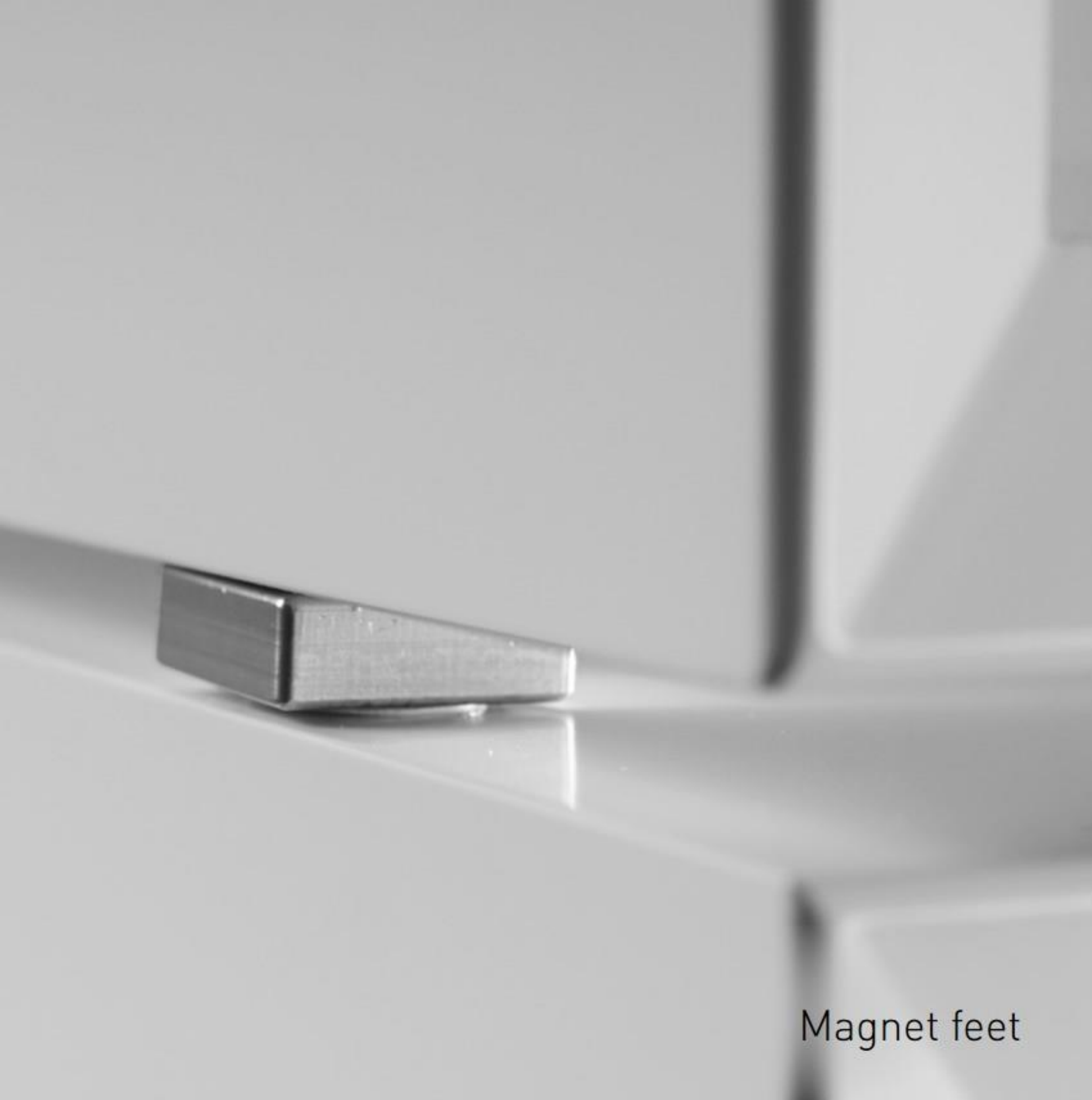

Magnet feet

IPAD POND

With a clic iPad pond (Registered design) you can integrate your iPad in the top plate of the furniture.

When your iPad is placed in the furniture, the top of the iPad will be aligned with the top of the furniture.

With the help of 4 rubber buttons at the bottom of the pond it's easy to tilt up the iPad when you want to bring it with you.

Go to functions on clic.dk to see the type of iPad's you can order the iPad pond for.



iPad Pond

CABLE HOLES

All clic models have one cable hole center in the top plate as standard.

When ordering a clic furniture it is important to consider how many cable holes you need. For instance: Do you need cables from the furniture up to your flatscreen, a turntable or a lamp? Or do you need extra cable holes for our charger or ventilation solution?

You can also order the furniture with no holes in the top plate.



Model 230 with 3 cable holes

MOUNTING

The clic furniture can be stacked on top of each other by using our magnet feet or placed on the wall with clic wall brackets.

Most clic models can be mounted on alu stands 1, 2, 3 or wheels.

On clic.dk you can see how each model can be mounted.



Alu stands 1



Alu stands 2



Alu stands 3



Cable cover 05a



Cable cover 05b



Cable cover 05c



Cable cover 05d

FIREPLACE

With a clic bioethanol fireplace you can integrate the warm and cosy feeling in the top of your clic furniture.

VINYL HOLE

Store your favorite vinyl records in our special designed vinyl hole (Registered design) and flip through your favorites. Larger vinyl collections can be stored ordinarily in a clic furniture with or without a door.



Model 211 and 221-2

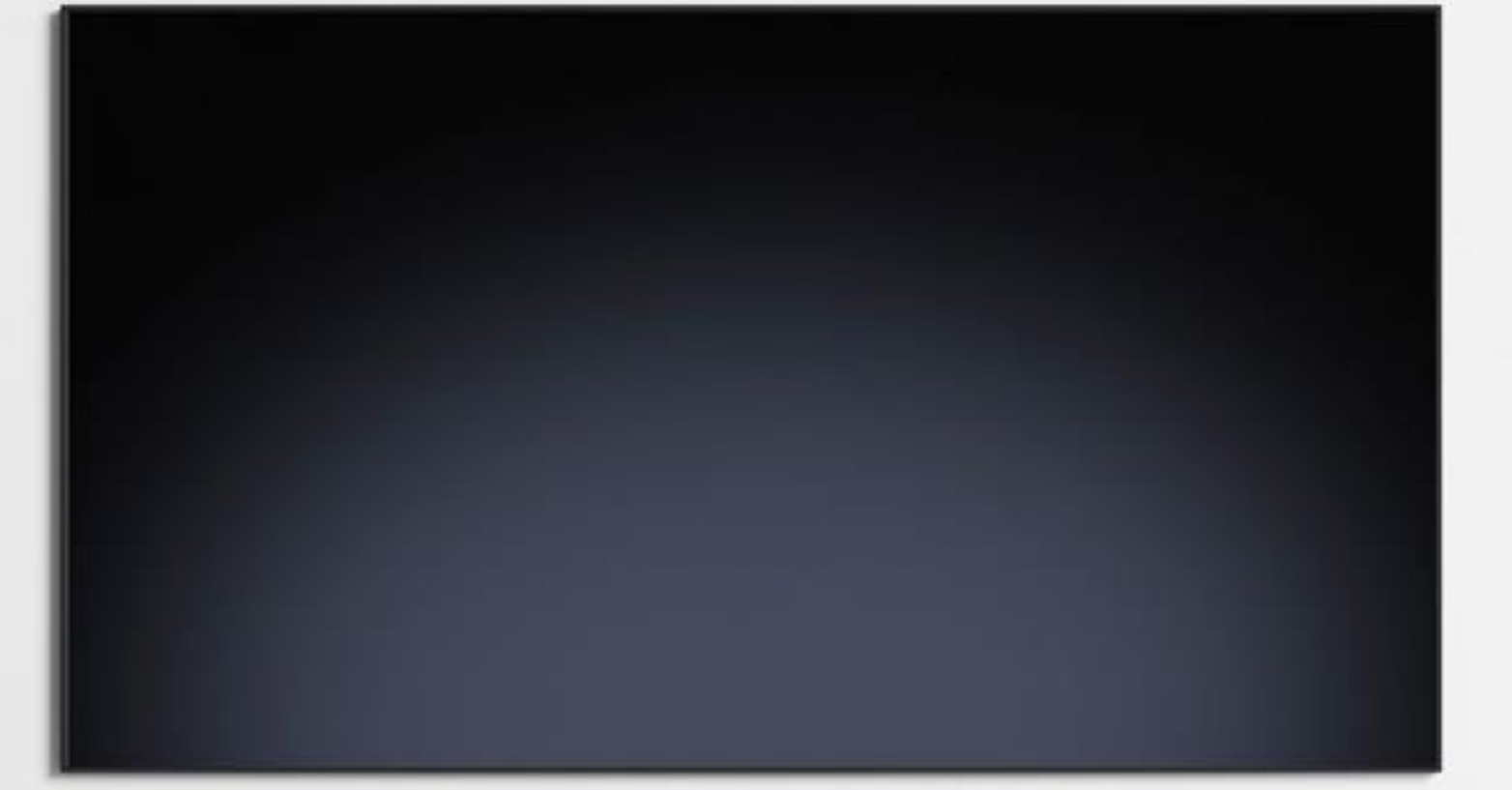

Model 221-2 lightgrey

BACK PLATES

The clic furniture are fitted with removable back plates. The furniture are just as stable with or without the back plates.

The back plates are fitted with magnets and are placed 5 cm. from the back of the furniture to provide space behind them for cables etc.



Back plates



Model 220-2 in grey with vinyl hole

ENDLESS POSSIBILITIES

The clic furniture are available in 4 depths, 5 widths and 4 heights. They can be combined in countless ways and offers plenty of opportunities to create a personal expression in the room.

The range of models and functions will solve your decor needs whether your wish is a stylish way to store your vinyl collection, music system, subwoofer or maybe your book collection.

You can play with the different colours or choose a classic solution in the new walnut or oak veneer. You can dial up the minimalistic look and hide everything from your Bob Dylan collection to your Glenlivet's behind doors or drawers or you can choose a more unique expression with open rooms and let the furniture display your items.

It's all a question of style, taste and courage.

VINYL LOVER

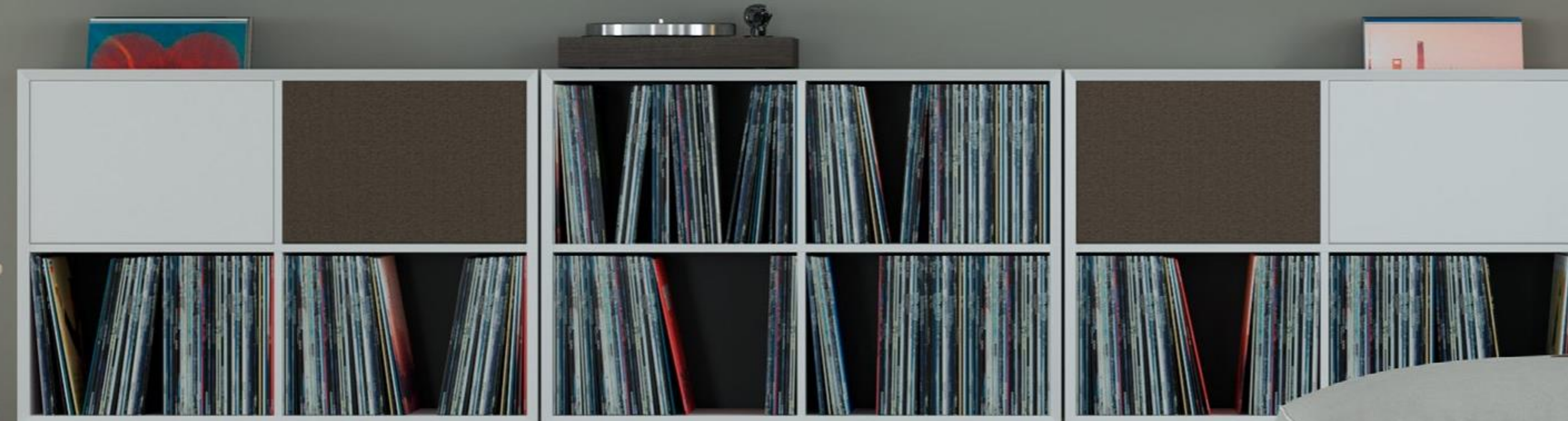

MOVIE FAN



REMEMBER WHEN ORDERING

IF YOU HAVE ANY QUESTIONS OR
NEED HELP, PLEASE CONTACT YOUR
CLIC DEALER OR CLIC DIRECT ON
+45 8699 7400 OR INFO@CLIC.DK

1.

DEPTH

clíc's models are available in 4 depths.
The first thing you have to do is find out
what your need for depth is.

2.

MODEL

When you have decided on the depth, you need to
choose your model. On the following pages you can
see what models are available in the different depths.

3.

COLOUR

Then you have to choose colour or finish on your
furniture. All models are available in white, lightgrey,
grey and black paint as well as oak and walnut veneer.

4.

NUMBER OF HOLES IN TOP PLATE

It's important that you decide how many top
holes you need in your furniture.
A top hole will always be placed center above
a room, but it's completely optional if you
want 1, 2, 3 or no top holes in for example a
model 231.

5.

FUNCTIONS IN THE TOP

If you want to integrate a vinyl hole,
iPad pond or a fireplace in the top
of your furniture, don't forget to add
this to your order.
On our website you can see what
models can be ordered with these
functions.

6.

BACK PLATES

clíc's removable back plates comes in white and black,
with and without cable holes for cabling.
The back plates are included in the furniture price.
White and lightgrey furniture are fitted with white back
plates. Black, grey and veneer furniture are fitted with
black back plates. If you want a different configuration
just make sure to make a note on that in your order.

7.

DOORS AND DRAWERS

You can choose between fabric and wooden doors.
The fabric doors are available in 2 quality's and a total
of 16 different colours. Wooden doors and drawers are
available in the same paint and veneer colours as the
furniture. On our website under each model you can see
if the model you want can be fitted with drawers.
When you have decided on doors and drawers make
sure to add to the order how you want them placed in
the furniture and what side you want the doors hinged.

8.

MOUNTING AND ACCESSORIES

Your final decision is how you want your
furniture mounted and what accessories
you need – wall brackets, alu stands,
cables covers etc.

DEPTH 26,5 CM

All clic models have one cable hole center in the top plate. If you want your clic furniture without holes or with extra holes remember to add this information on your order.

When removing the back plate the internal depth is 253mm

Find further measurements on clic.dk

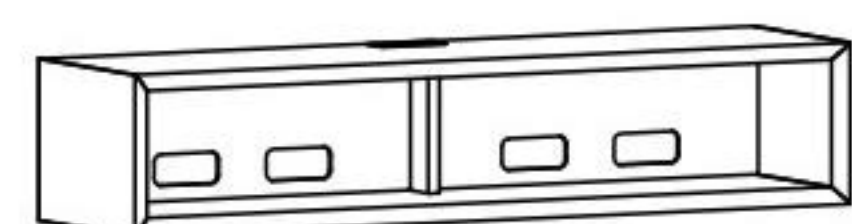

MODEL 12S

1 room · 2 back plates

Paint: White, lightgrey, grey or black

Veneer: Oak or walnut

Outer measurements: H:205mm, W:1024mm, D:265mm

Inner measurements: H:162mm, W:482mm/980mm*, D:199,5mm/152mm*

*Measurements when using model 12S as a soundbar solution

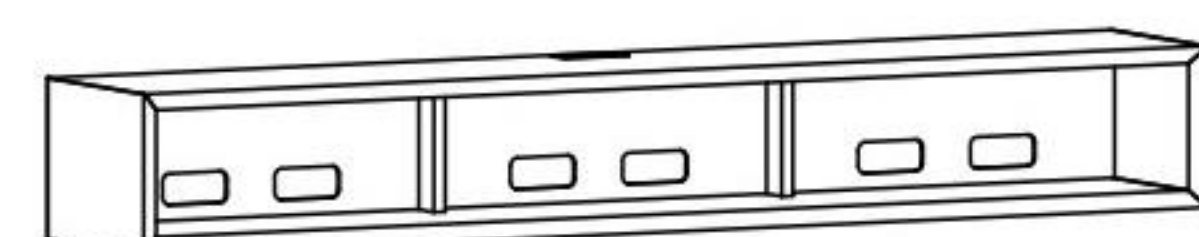

MODEL 13S

1 room · 3 back plates

Paint: White, lightgrey, grey or black

Veneer: Oak or walnut

Outer measurements: H:205mm, W:1522mm, D:265mm

Inner measurements: H:162mm, W:482mm/1478mm*, D:199,5mm/152mm*

*Measurements when using model 13S as a soundbar solution

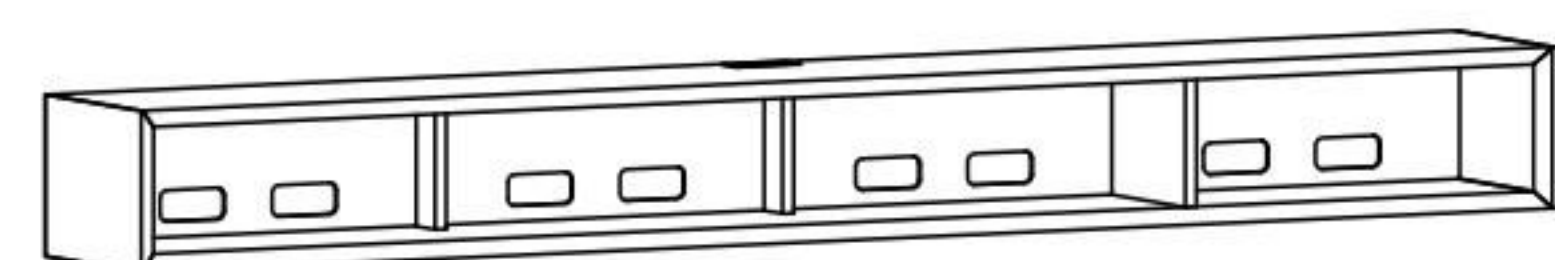

MODEL 14S LEFT

2 rooms · 4 back plates

Paint: White, lightgrey, grey or black

Veneer: Oak or walnut

Outer measurements: H:205mm, W:2020mm, D:265mm

Inner measurements: H:162mm, W:482mm/1478mm*, D:199,5mm/152mm*

*Measurements when using model 14S Left as a soundbar solution

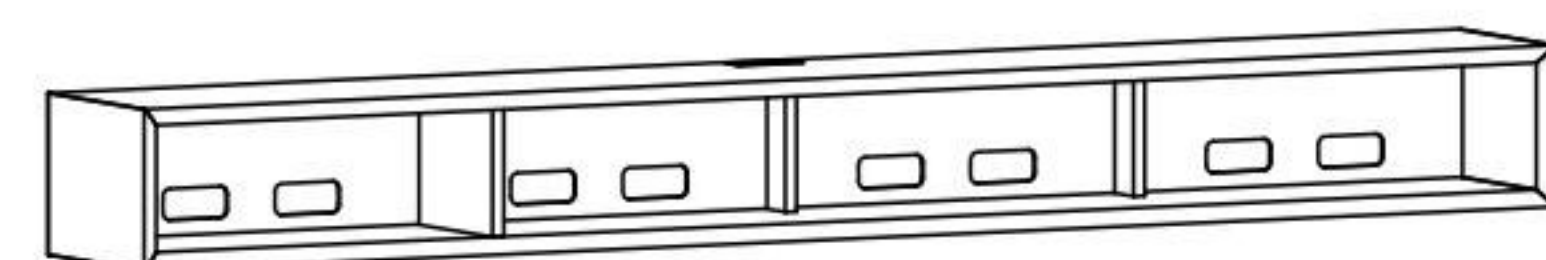

MODEL 14S RIGHT

2 rooms · 4 back plates

Paint: White, lightgrey, grey or black

Veneer: Oak or walnut

Outer measurements: H:205mm, W:2020mm, D:265mm

Inner measurements: H:162mm, W:482mm/1478mm*, D:199,5mm/152mm*

*Measurements when using model 14S Right as a soundbar solution



DEPTH 37,5 CM

All clic models have one cable hole center in the top plate. If you want your clic furniture without holes or with extra holes remember to add this information on your order.

When removing the back plate the internal depth is 363mm

Find further measurements on clic.dk

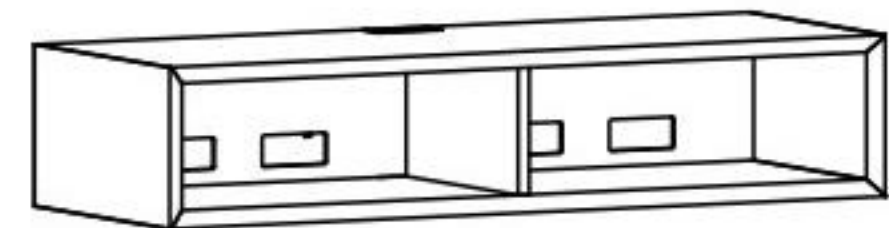

MODEL 120

2 rooms · 2 back plates

Paint: White, lightgrey, grey or black
Veneer: Oak or walnut

Outer measurements: H:205mm, W:1024mm, D:375mm
Inner measurements for each room: H:162mm, W:482mm, D:314mm

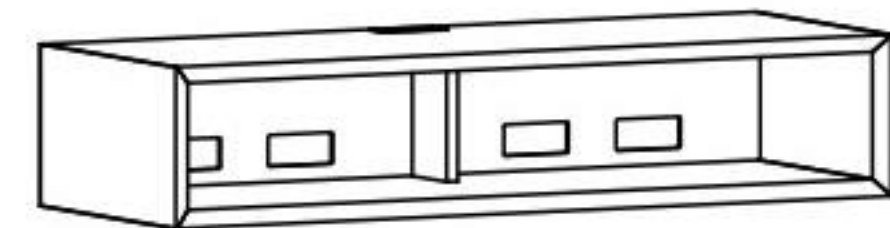

MODEL 120S

1 room · 2 back plates

Paint: White, lightgrey, grey or black
Veneer: Oak or walnut

Outer measurements: H:205mm, W:1024mm, D:375mm
Inner measurements for each room: H:162mm, W:980mm*/482mm, D:314mm *measurements when using model 120S as a soundbar solution

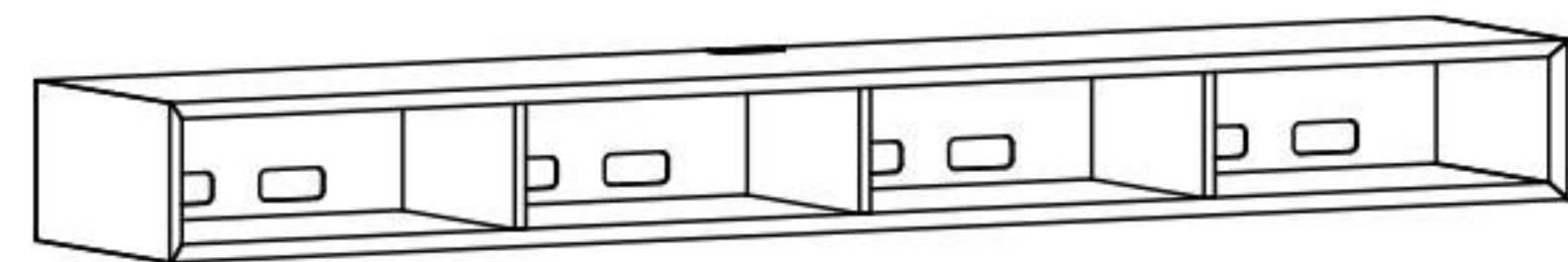

MODEL 140

4 rooms · 4 back plates

Paint: White, lightgrey, grey or black
Veneer: Oak or walnut

Outer measurements: H:205mm, W:2020mm, D:375mm
Inner measurements for each room: H:162mm, W:482mm, D:314mm

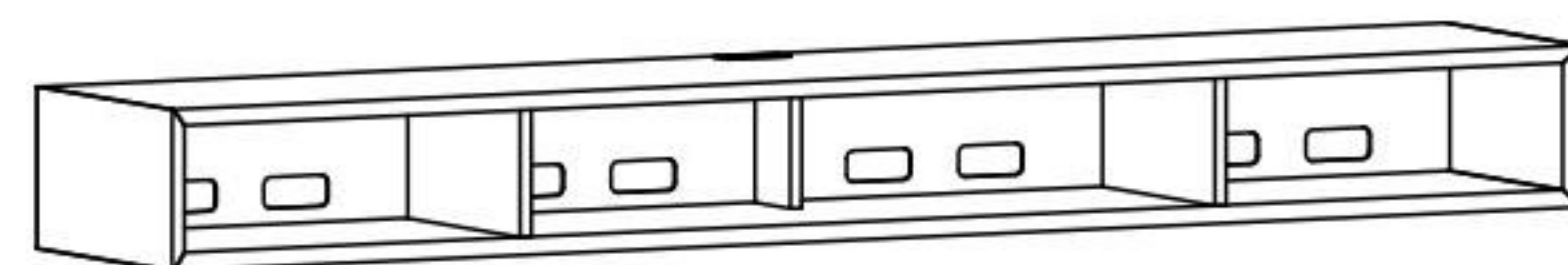

MODEL 140 CENTER

3 room · 4 back plates

Paint: White, lightgrey, grey or black
Veneer: Oak or walnut

Outer measurements: H:205mm, W:2020mm, D:375mm
Inner measurements for each room: H:162mm, W:482mm/980mm*, D:314mm *Measurements when using model 240 Center as a soundbar/center solution

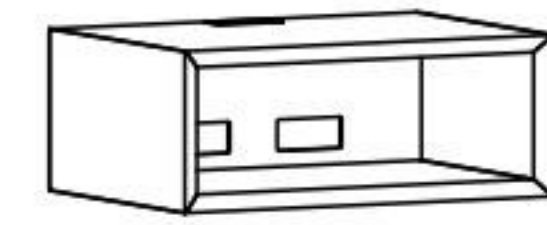

MODEL 110

1 room · 1 back plate

Paint: White, lightgrey, grey or black
Veneer: Oak or walnut

Outer measurements: H:205mm, W:526mm, D:375mm
Inner measurements: H:162mm, W:482mm, D:314mm

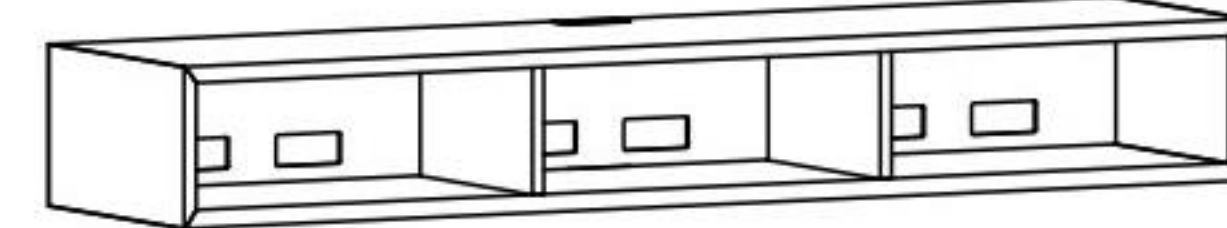

MODEL 130

3 rooms · 3 back plates

Paint: White, lightgrey, grey or black
Veneer: Oak or walnut

Outer measurements: H:205mm, W:1522mm, D:375mm
Inner measurements for each room: H:162mm, W:482mm, D:314mm

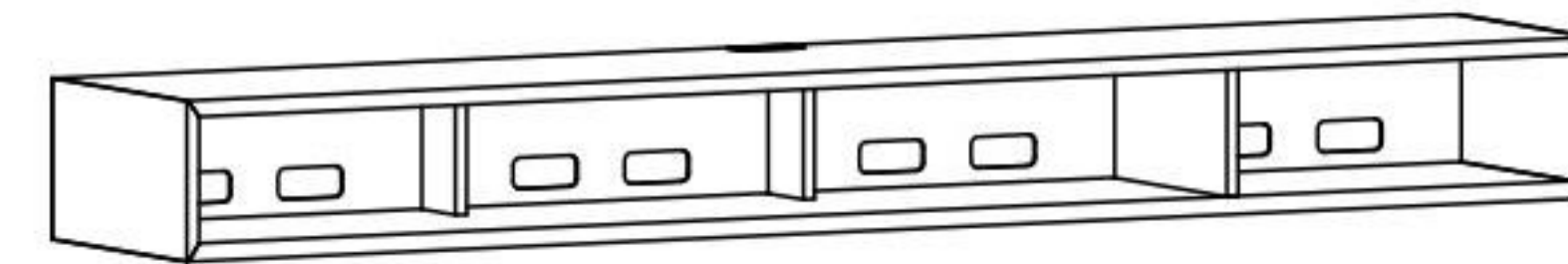

MODEL 140S LEFT

2 room · 4 back plates

Paint: White, lightgrey, grey or black
Veneer: Oak or walnut

Outer measurements: H:205mm, W:2020mm, D:375mm
Inner measurements for each room: H:162mm, W:482mm/1478mm*, D:314mm *Measurements when using model 140S Left as a soundbar solution

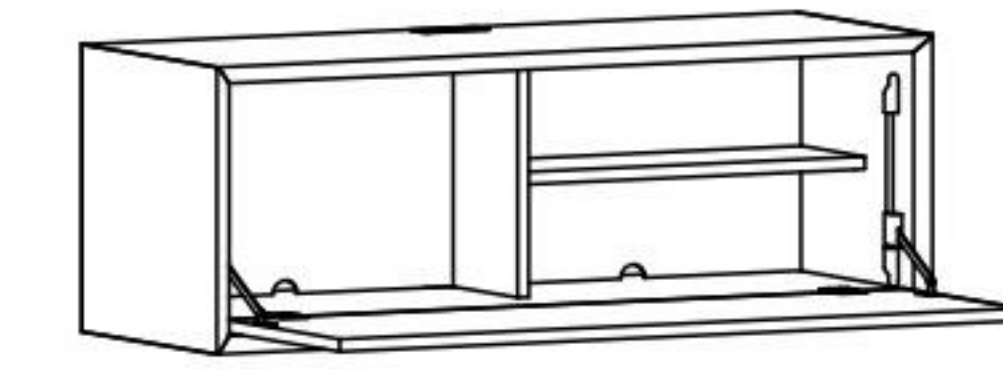

MODEL DESKTOP

2 rooms · 1 shelf · 2 back plates · flap

Paint: White, lightgrey, grey or black
Veneer: Oak or walnut

Outer measurements: H:366mm, W:1024mm, D:375mm
Inner measurements for each room: H:305mm, W:980mm/W:482mm, D:298mm **incl. flap**

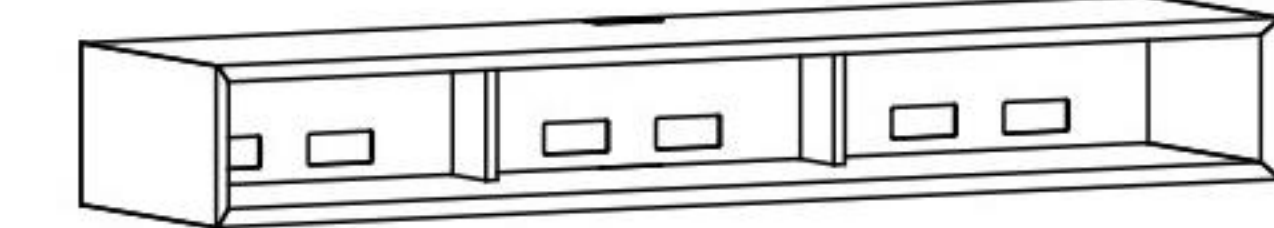

MODEL 130S

1 room · 3 back plates

Paint: White, lightgrey, grey or black
Veneer: Oak or walnut

Outer measurements: H:205mm, W:1522mm, D:375mm
Inner measurements for each room: H:162mm, W:1478mm*/W:482mm, D:314mm *measurements when using model 130S as a soundbar solution

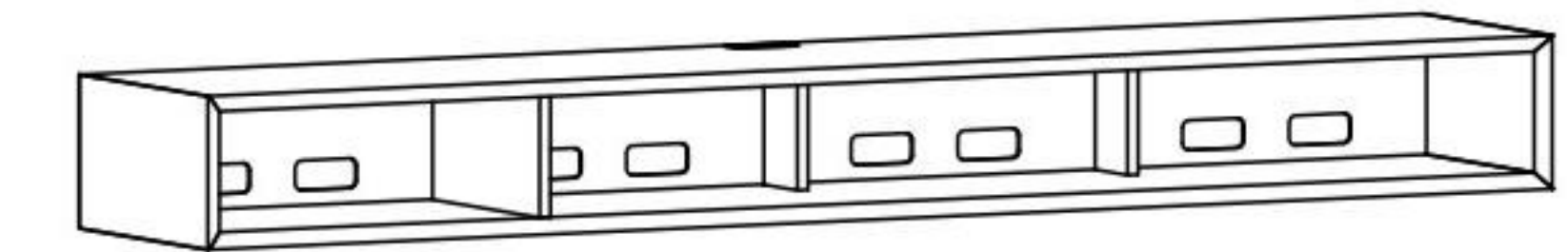

MODEL 140S RIGHT

2 rooms · 4 back plates

Paint: White, lightgrey, grey or black
Veneer: Oak or walnut

Outer measurements: H:205mm, W:2020mm, D:375mm
Inner measurements for each room: H:162mm, W:482mm/1478mm*, D:314mm *Measurements when using model 140S Right as a soundbar solution

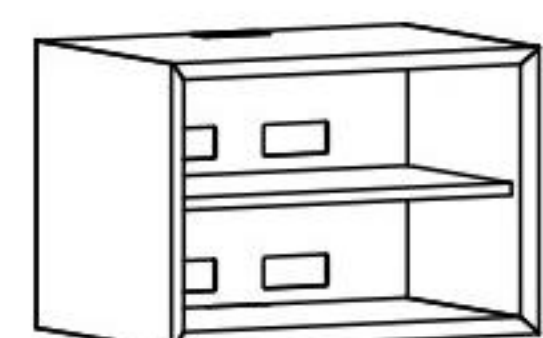

MODEL 210

1 room · 1 shelf · 1 back plate

Paint: White, lightgrey, grey or black
Veneer: Oak or walnut

Outer measurements: H:366mm, W:526mm, D:375mm
Inner measurements: H:322mm, W:482mm, D:314mm



MODEL 210 LARGE

1 room · 1 shelf · 1 back plate

Paint: White, lightgrey, grey or black
Veneer: Oak or walnut

Outer measurements: H:366mm, W:692mm, D:375mm
Inner measurements: H:322mm, W:648mm, D:314mm

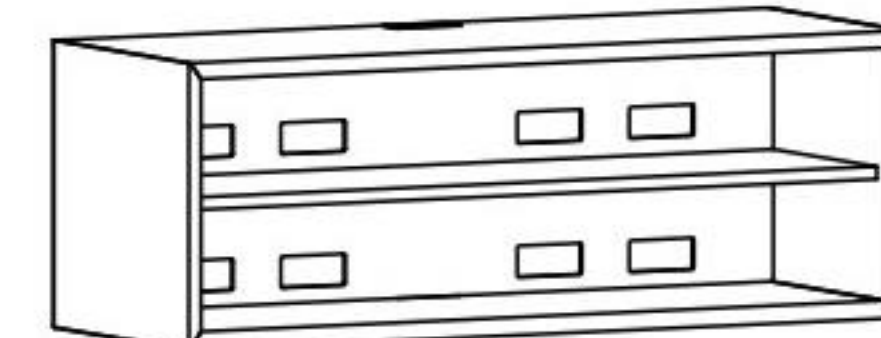

MODEL 220 CENTER

1 room · 1 shelf · 1 back plate

Paint: White, lightgrey, grey or black
Veneer: Oak or walnut

Outer measurements: H:366mm, W:1024mm, D:375mm
Inner measurements: H:322mm, W:980mm, D:314mm

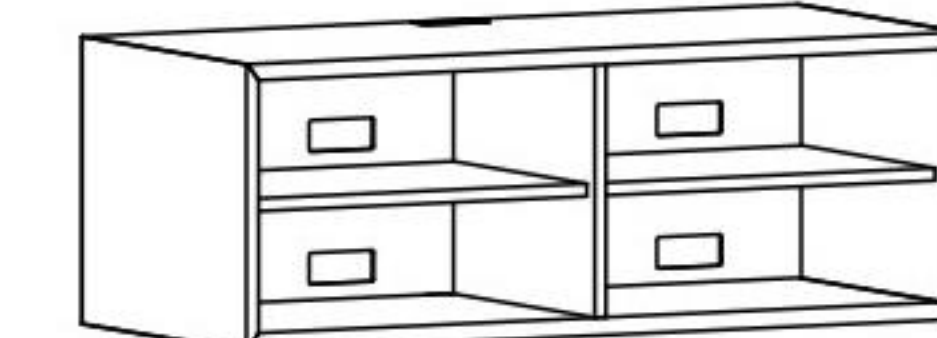

MODEL 220-2

2 rooms · 2 shelves · 2 back plates

Paint: White, lightgrey, grey or black
Veneer: Oak or walnut

Outer measurements: H:366mm, W:1024mm, D:375mm
Inner measurements for each room: H:322mm, W:482mm, D:314mm

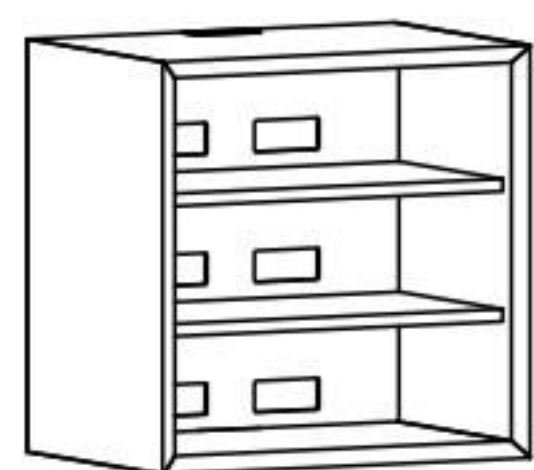

MODEL 310

1 room · 2 shelves · 1 back plate

Paint: White, lightgrey, grey or black

Veneer: Oak or walnut

Outer measurements: H:526mm, W:526mm, D:375mm
Inner measurements: H:482mm, W:482mm, D:314mm



MODEL 310 LARGE

1 room · 2 shelves · 1 back plate

Paint: White, lightgrey, grey or black

Veneer: Oak or walnut

Outer measurements: H:526mm, W:692mm, D:375mm
Inner measurements: H:482mm, W:648mm, D:314mm

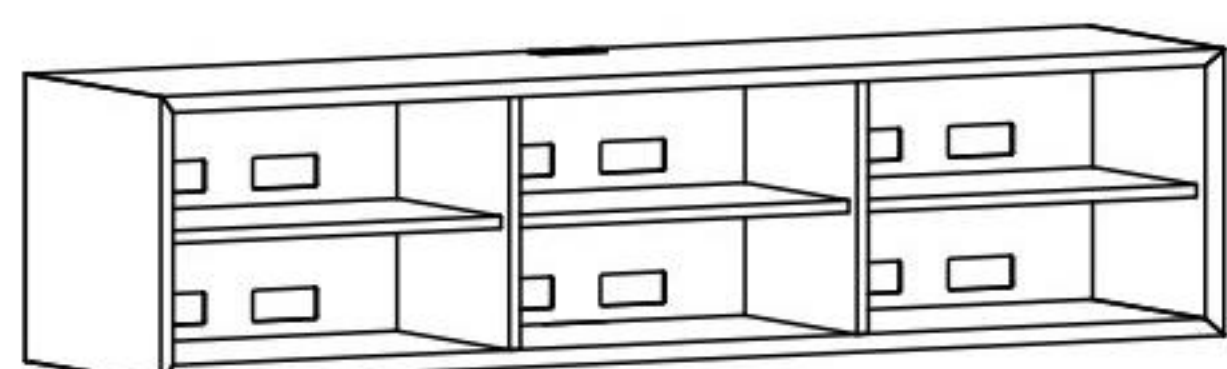

MODEL 230

3 rooms · 3 shelves · 3 back plates

Paint: White, lightgrey, grey or black

Veneer: Oak or walnut

Outer measurements: H:366mm, W:1522mm, D:375mm
Inner measurements for each room: H:322mm, W:482mm, D:314mm

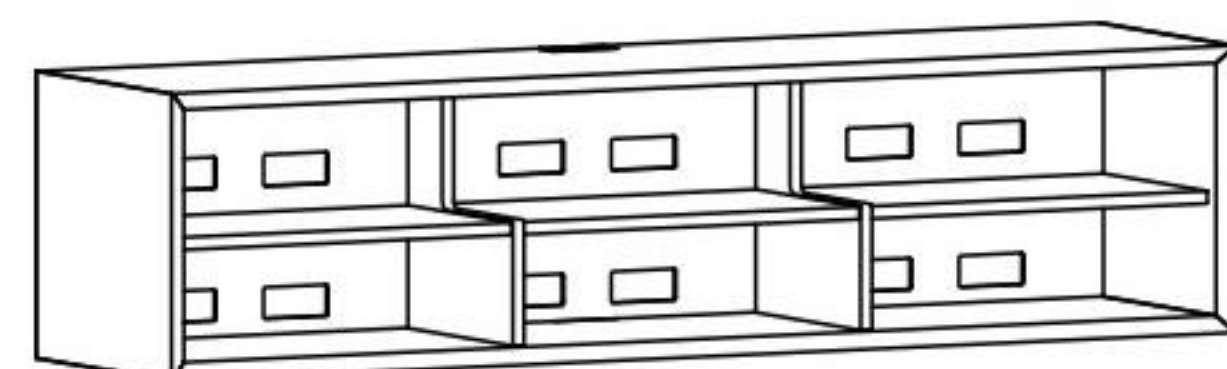

MODEL 230S

1 room · 3 shelves · 3 back plates

Paint: White, lightgrey, grey or black

Veneer: Oak or walnut

Outer measurements: H:366mm, W:1522mm, D:375mm
Inner measurements for each room: H:322mm/162mm*, W:1478mm*/W:482mm, D:314mm *Measurements when using the top shelf as a soundbar solution

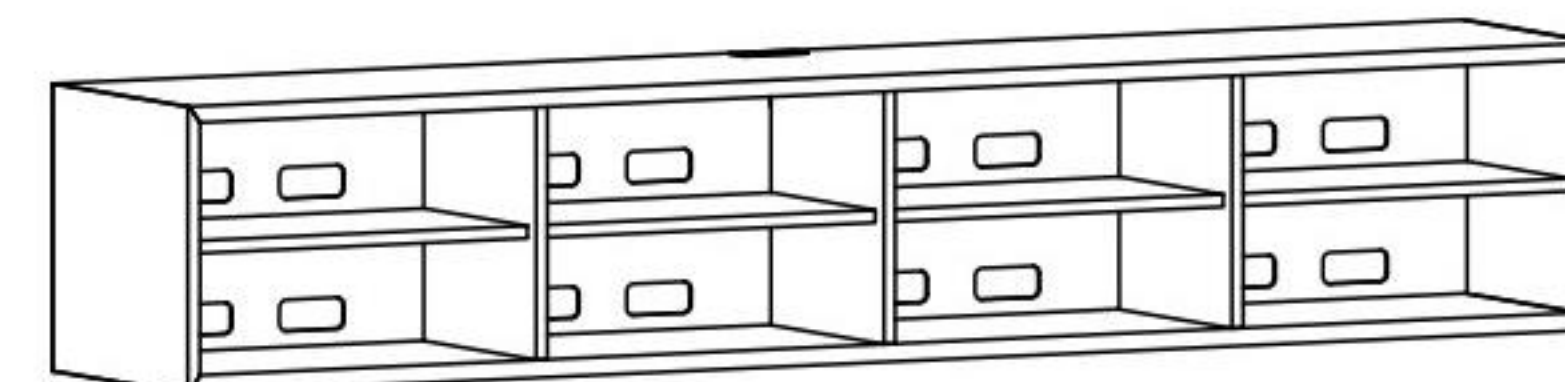

MODEL 240

4 rooms · 4 shelves · 4 back plates

Paint: White, lightgrey, grey or black

Veneer: Oak or walnut

Outer measurements: H:366mm, W:2020mm, D:375mm
Inner measurements for each room: H:322mm, W:482mm, D:314mm

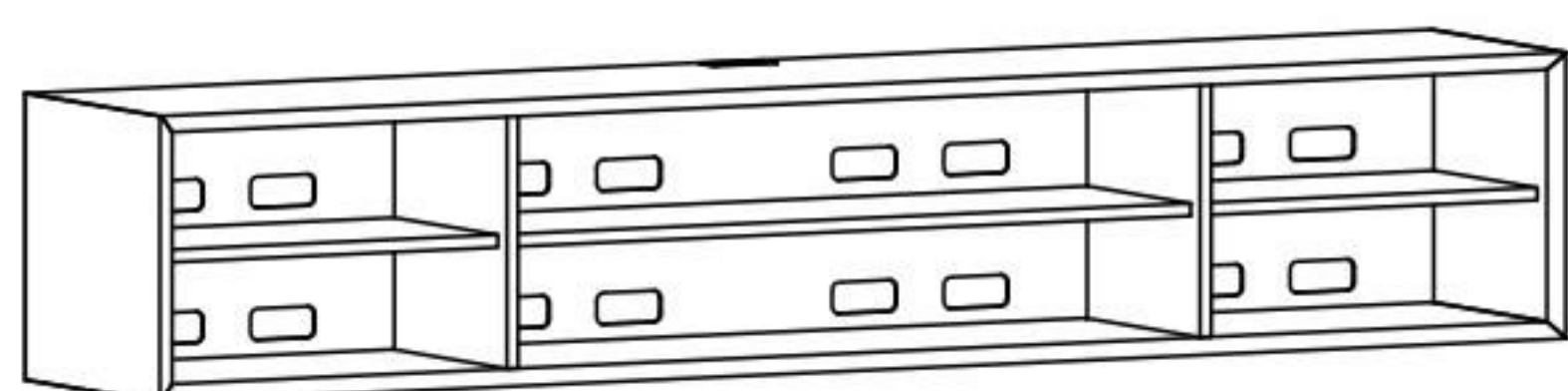

MODEL 240 CENTER

3 rooms · 3 shelves · 3 back plates

Paint: White, lightgrey, grey or black

Veneer: Oak or walnut

Outer measurements: H:366mm, W:2020mm, D:375mm
Inner measurements for each room: H:322mm, W:482mm/980mm*, D:314mm *Measurements when using model 240 Center as a soundbar/center solution

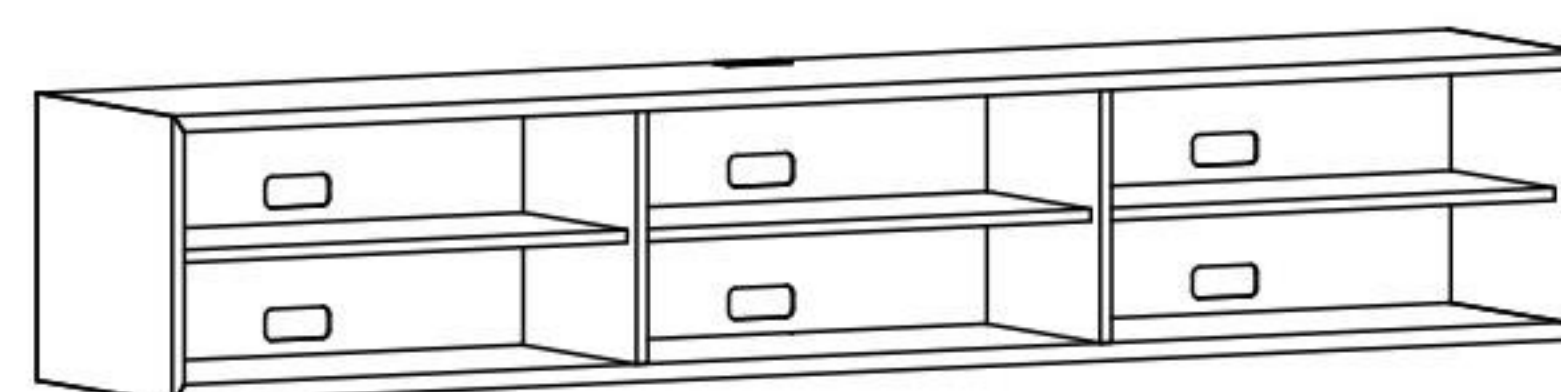

MODEL 240 LARGE

3 rooms · 3 shelves · 3 back plates

Paint: White, lightgrey, grey or black

Veneer: Oak or walnut

Outer measurements: H:366mm, W:2020mm, D:375mm
Inner measurements for each room: H:322 mm, W:648mm, D:314mm

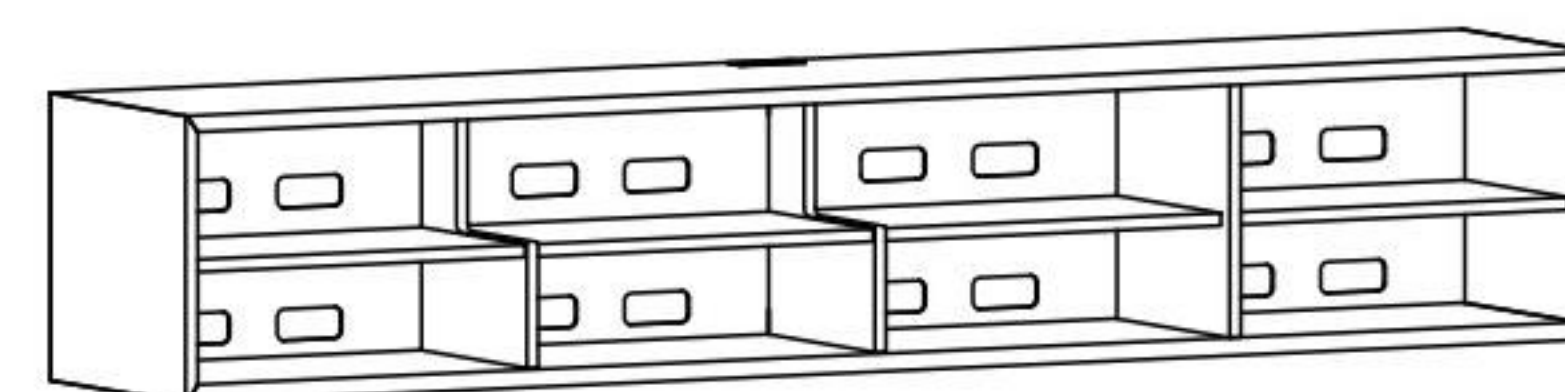

MODEL 240S LEFT

2 rooms · 4 shelves · 4 back plates

Paint: White, lightgrey, grey or black

Veneer: Oak or walnut

Outer measurements: H:366mm, W:2020mm, D:375mm
Inner measurements for each room: H:322mm/162mm*, W:1478mm*/482mm, D:314mm *Measurements when using the top shelf as a soundbar solution

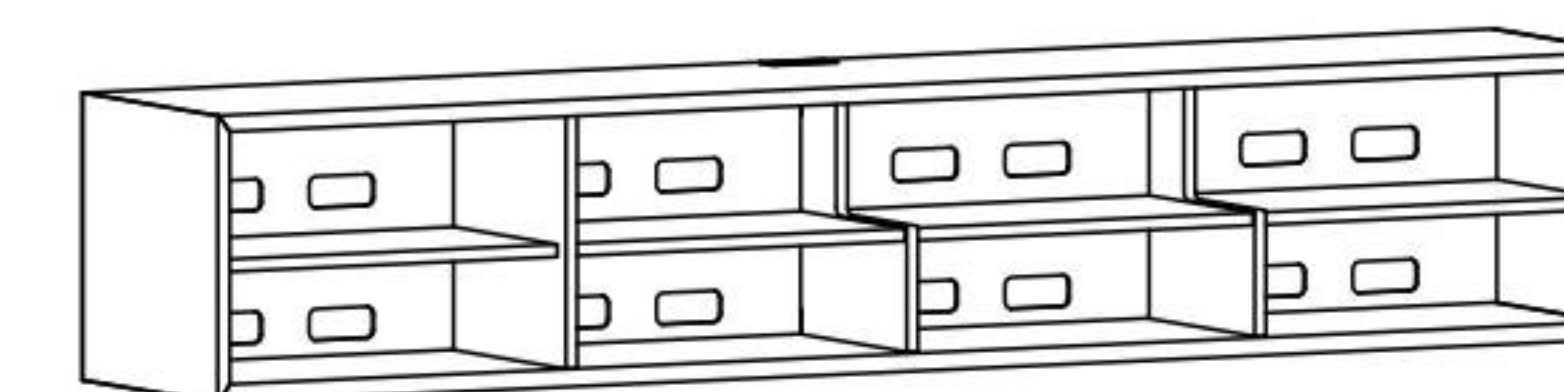

MODEL 240S RIGHT

2 rooms · 4 shelves · 4 back plates

Paint: White, lightgrey, grey or black

Veneer: Oak or walnut

Outer measurements: H:366mm, W:2020mm, D:375mm
Inner measurements for each room: H:322mm/162mm*, W:1478mm/482mm, D:314mm *Measurements when using the top shelf as a soundbar solution

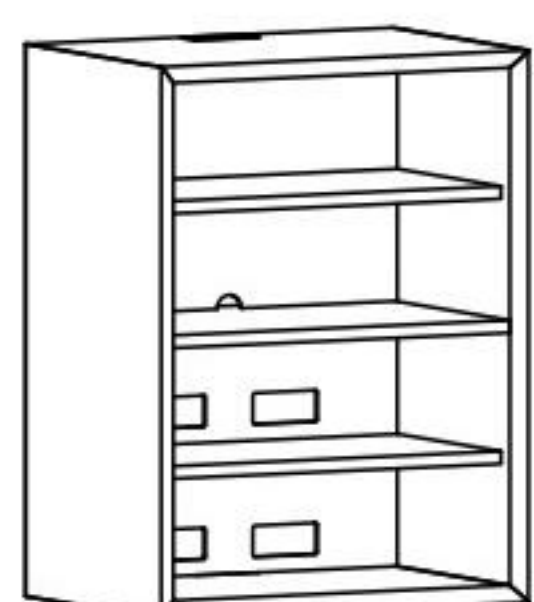

MODEL 410

2 rooms · 2 shelves · 2 back plates

Paint: White, lightgrey, grey or black

Veneer: Oak or walnut

Outer measurements: H:704mm, W:526mm, D:375mm
Inner measurements for each room: H:322mm, W:482mm, D:314mm

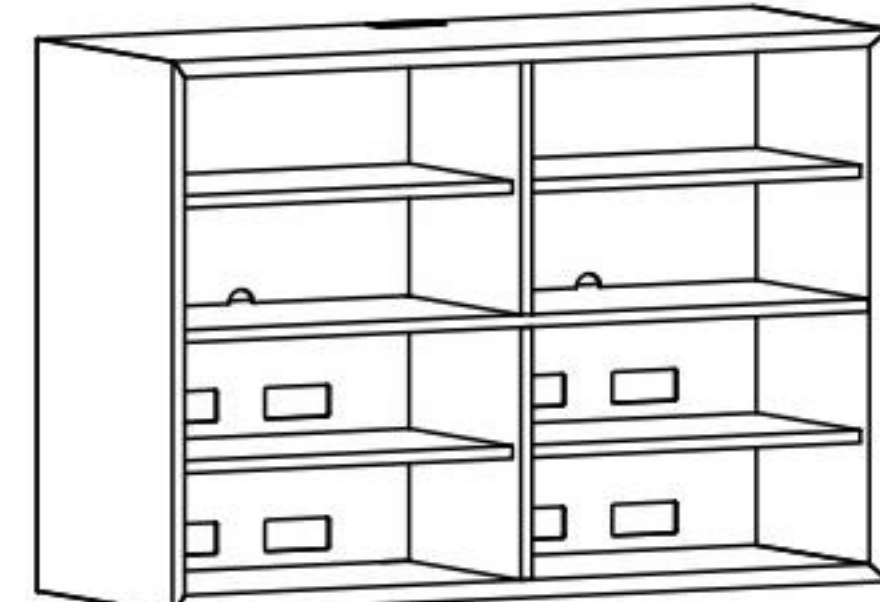

MODEL 420

4 rooms · 4 shelves · 4 back plates

Paint: White, lightgrey, grey or black

Veneer: Oak or walnut

Outer measurements: H:704mm, W:1024mm, D:375mm
Inner measurements for each room: H:322mm, W:482mm, D:314mm

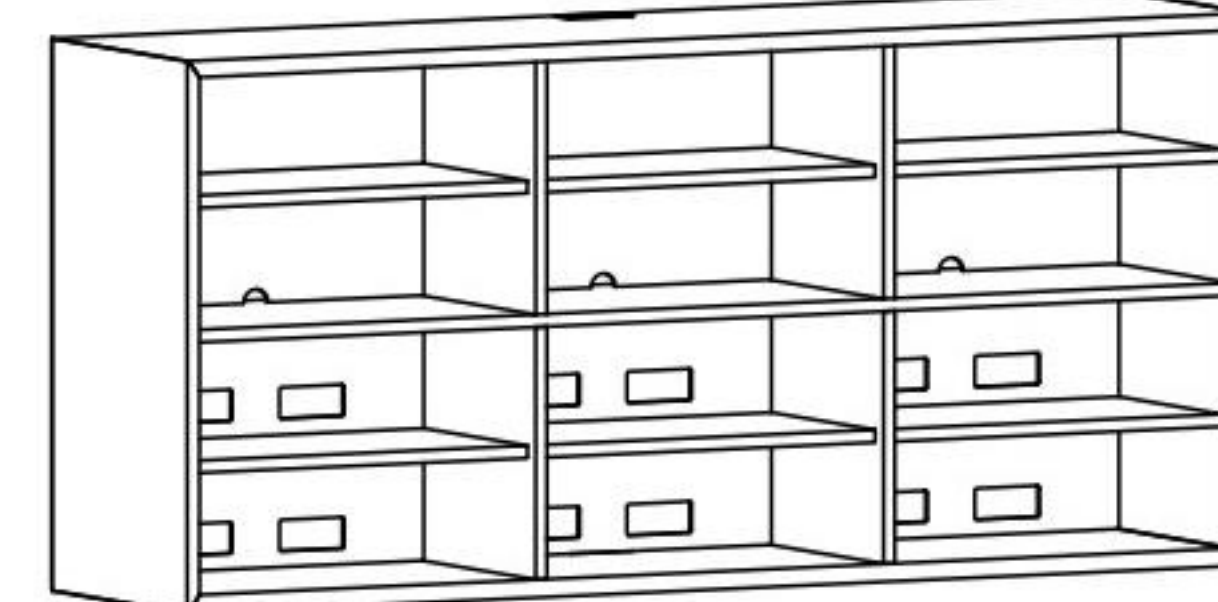

MODEL 430

6 rooms · 6 shelves · 6 back plates

Paint: White, lightgrey, grey or black

Veneer: Oak or walnut

Outer measurements: H:704mm, W:1522mm, D:375mm
Inner measurements for each room: H:322mm, W:482mm, D:314mm

DEPTH 45,5 CM

All clic models have one cable hole center in the top plate. If you want your clic furniture without holes or with extra holes remember to add this information on your order.

When removing the back plate the internal depth is 443mm

Find further measurements on clic.dk

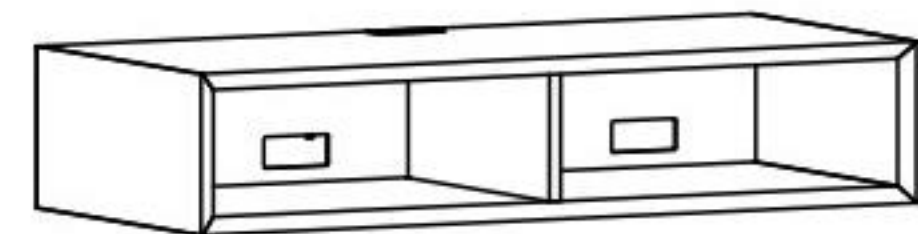

MODEL 121

2 rooms · 2 back plates

Paint: White, lightgrey, grey or black
Veneer: Oak or walnut

Outer measurements: H:205mm, W:1024mm, D:455mm
Inner measurements for each room: H:162mm, W:482mm, D:394mm

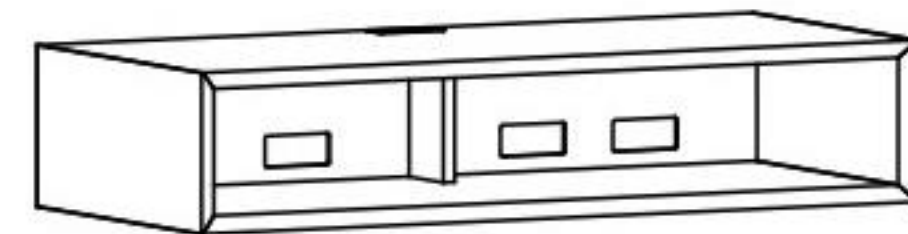

MODEL 121S

1 room · 2 back plates

Paint: White, lightgrey, grey or black
Veneer: Oak or walnut

Outer measurements: H:205mm, W:1024mm, D:455mm
Inner measurements for each room: H:162mm, W:980mm*/482mm, D:394mm *measurements when using model 121S as a soundbar solution

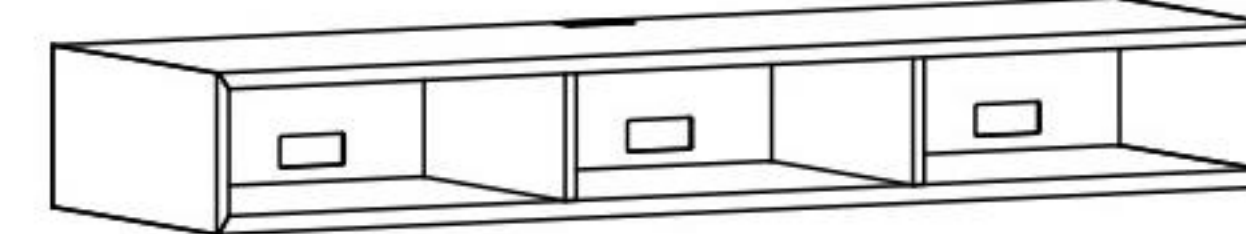

MODEL 131

3 rooms · 3 back plates

Paint: White, lightgrey, grey or black
Veneer: Oak or walnut

Outer measurements: H:205mm, W:1522mm, D:455mm
Inner measurements for each room: H:162mm, W:482mm, D:394mm

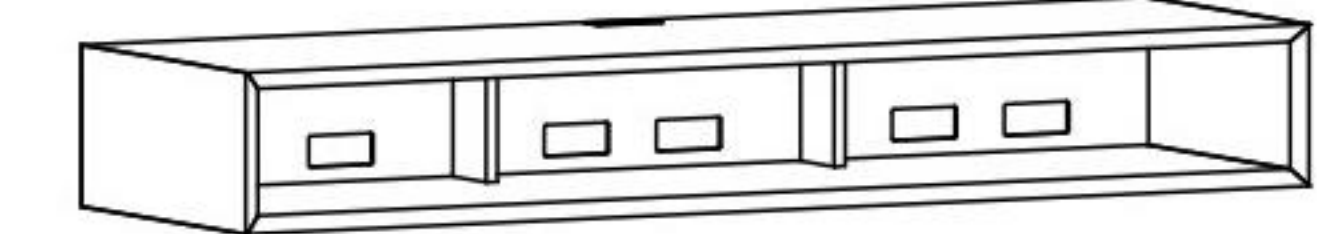

MODEL 131S

1 room · 3 back plates

Paint: White, lightgrey, grey or black
Veneer: Oak or walnut

Outer measurements: H:205mm, W:1522mm, D:455mm
Inner measurements for each room: H:162mm, W:1478mm*/482mm, D:394mm *measurements when using model 131S as a soundbar solution

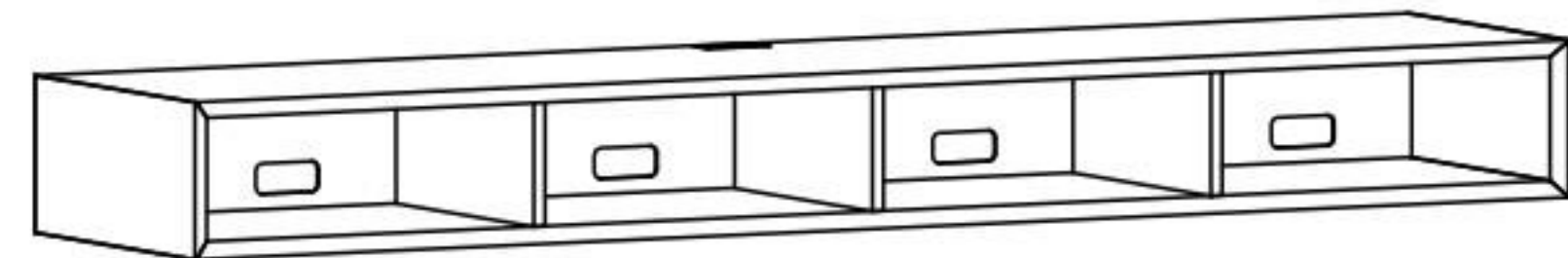

MODEL 141

4 rooms · 4 back plates

Paint: White, lightgrey, grey or black
Veneer: Oak or walnut

Outer measurements: H:205mm, W:2020mm, D:455mm
Inner measurements for each room: H:162mm, W:482mm, D:394mm

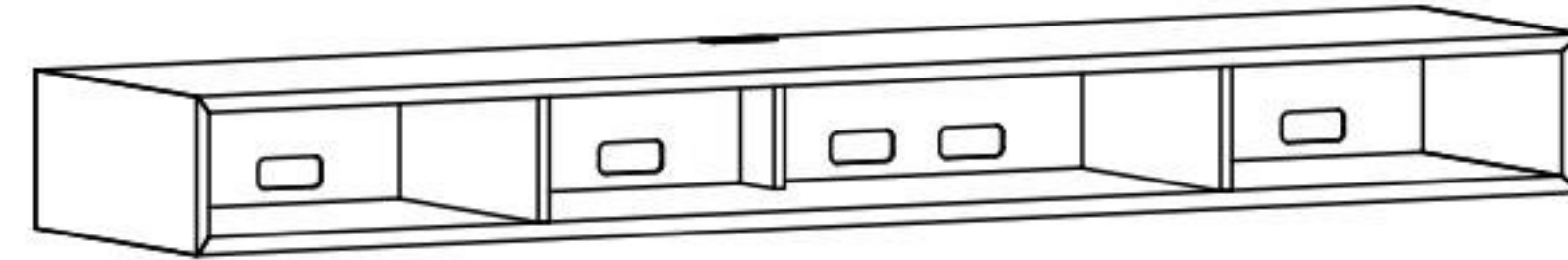

MODEL 141 CENTER

3 rooms · 4 back plates

Paint: White, lightgrey, grey or black
Veneer: Oak or walnut

Outer measurements: H:205mm, W:2020mm, D:455mm
Inner measurements for each room: H:162mm, W:482mm/980mm*, D:394mm *Measurements when using model 240 Center as a soundbar/center solution

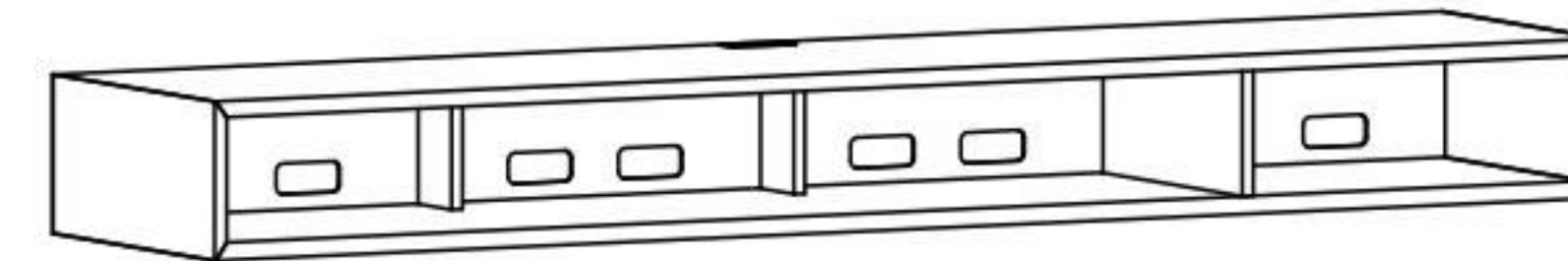

MODEL 141S LEFT

2 rooms · 4 back plates

Paint: White, lightgrey, grey or black
Veneer: Oak or walnut

Outer measurements: H:205mm, W:2020mm, D:455mm
Inner measurements for each room: H:162mm, W:482mm/1478mm*, D:394mm *Measurements when using model 141S Left as a soundbar solution

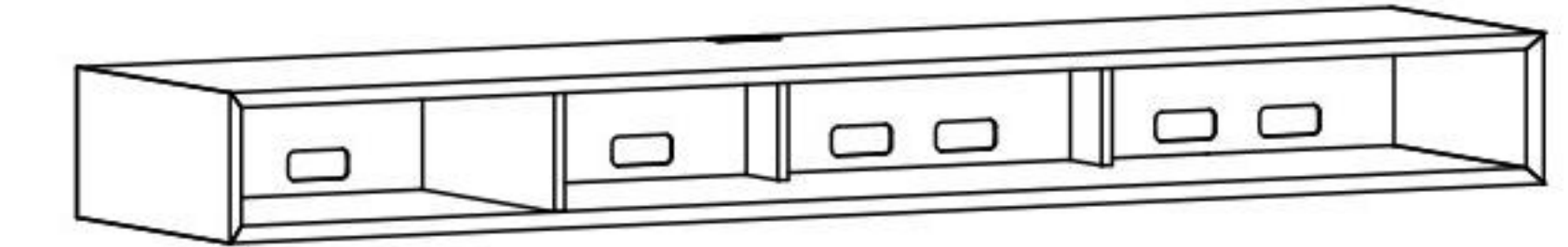

MODEL 141S RIGHT

2 rooms · 4 back plates

Paint: White, lightgrey, grey or black
Veneer: Oak or walnut

Outer measurements: H:205mm, W:2020mm, D:455mm
Inner measurements for each room: H:162mm, W:482mm/1478mm*, D:394mm *Measurements when using model 141S Right as a soundbar solution

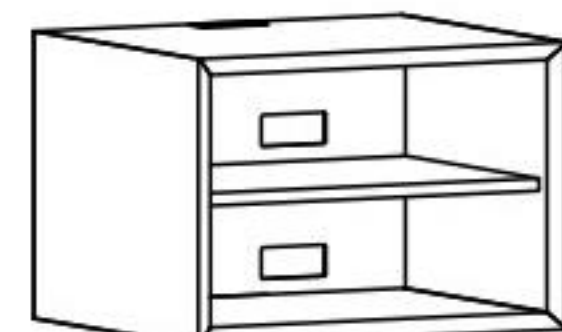

MODEL 211

1 room · 1 shelf · 1 back plate

Paint: White, lightgrey, grey or black
Veneer: Oak or walnut

Outer measurements: H:366mm, W:526mm, D:455mm
Inner measurements: H:322mm, W:482mm, D:394mm

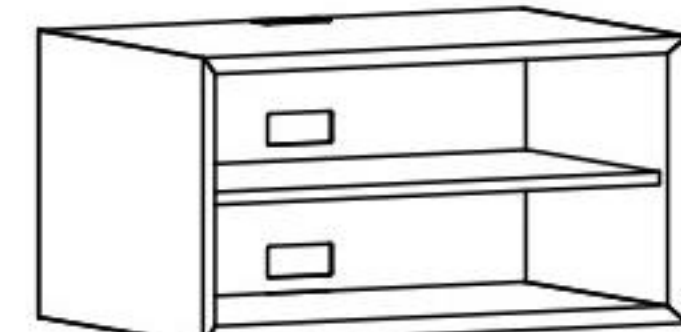

MODEL 211 LARGE

1 room · 1 shelf · 1 back plate

Paint: White, lightgrey, grey or black
Veneer: Oak or walnut

Outer measurements: H:366mm, W:692mm, D:455mm
Inner measurements: H:322mm, W:648mm, D:394mm

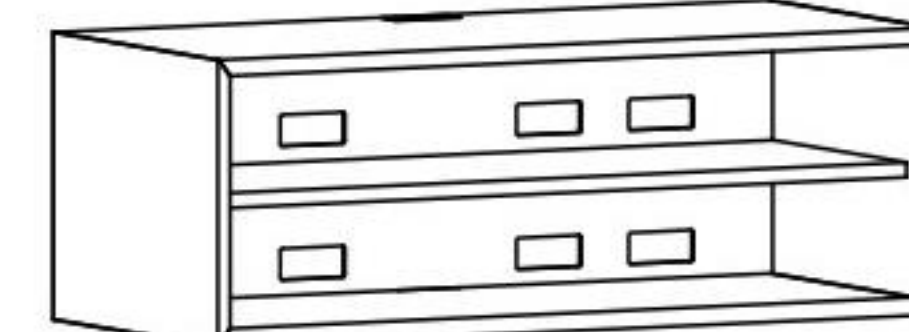

MODEL 221 CENTER

1 room · 1 shelf · 1 back plate

Paint: White, lightgrey, grey or black
Veneer: Oak or walnut

Outer measurements: H:366mm, W:1024mm, D:455mm
Inner measurements: H:322mm, W:980mm, D:394mm

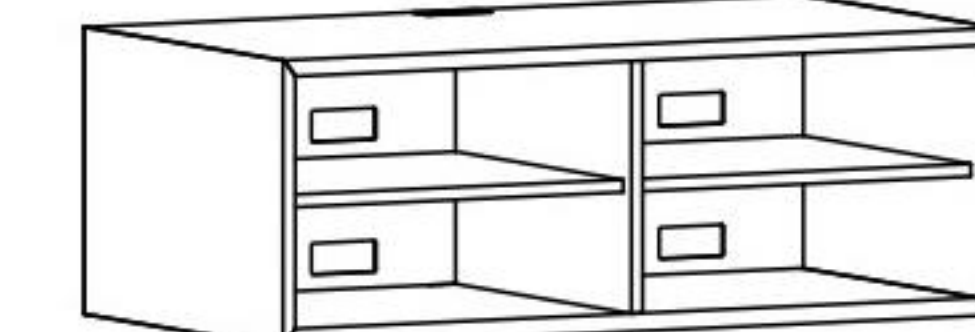

MODEL 221-2

2 rooms · 2 shelves · 2 back plates

Paint: White, lightgrey, grey or black
Veneer: Oak or walnut

Outer measurements: H:366mm, W:1024mm, D:455mm
Inner measurements for each room: H:322mm, W:482mm, D:394mm

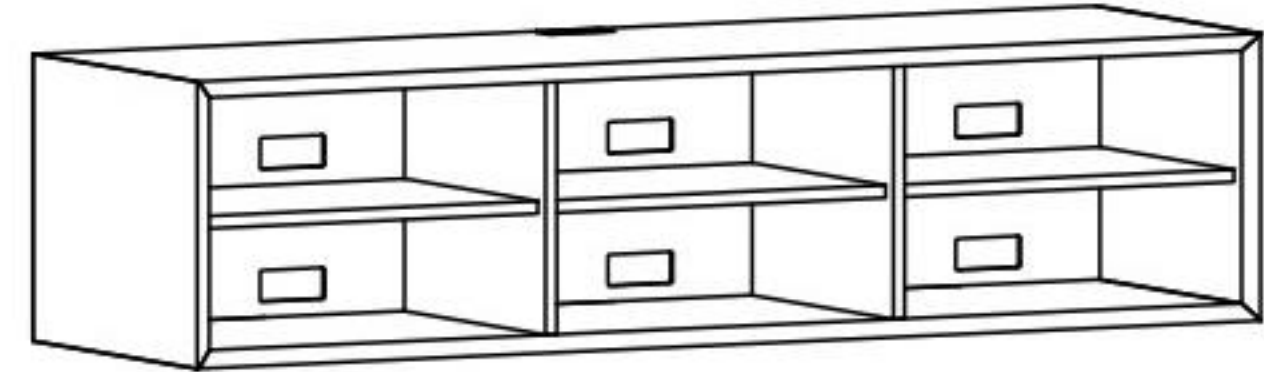

MODEL 231

3 rooms · 3 shelves · 3 back plates

Paint: White, lightgrey, grey or black

Veneer: Oak or walnut

Outer measurements: H:366mm, W:1522mm, D:455mm
Inner measurements for each room: H:322mm, W:482mm, D:394mm

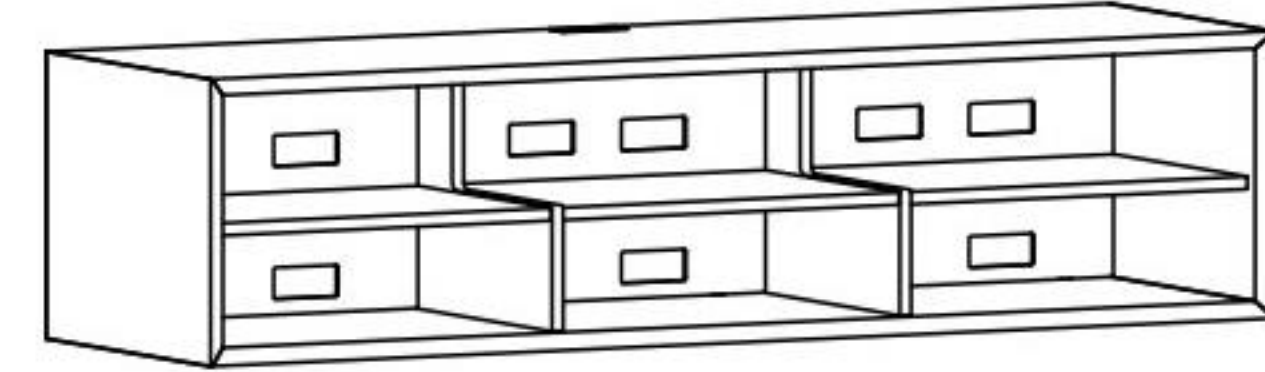

MODEL 231S

1 room · 3 shelves · 3 back plates

Paint: White, lightgrey, grey or black

Veneer: Oak or walnut

Outer measurements: H:366mm, W:1522mm, D:455mm
Inner measurements for each room: H:322mm/162mm*, W:1478mm*/W:482mm, D:394mm *Measurements when using the top shelf as a soundbar solution

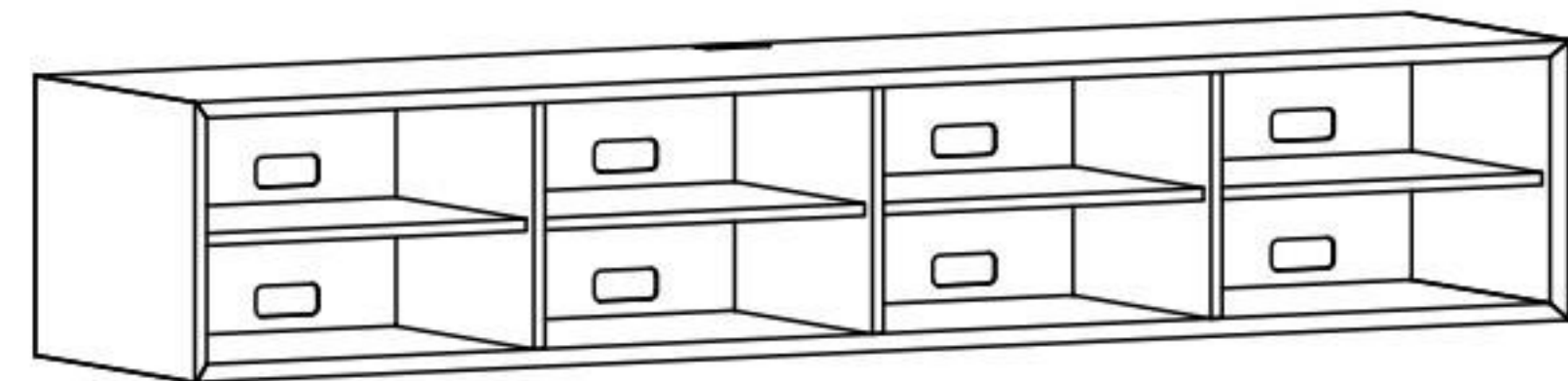

MODEL 241

4 rooms · 4 shelves · 4 back plates

Paint: White, lightgrey, grey or black

Veneer: Oak or walnut

Outer measurements: H:366mm, W:2020mm, D:455mm
Inner measurements for each room: H:322mm, W:482mm, D:394mm

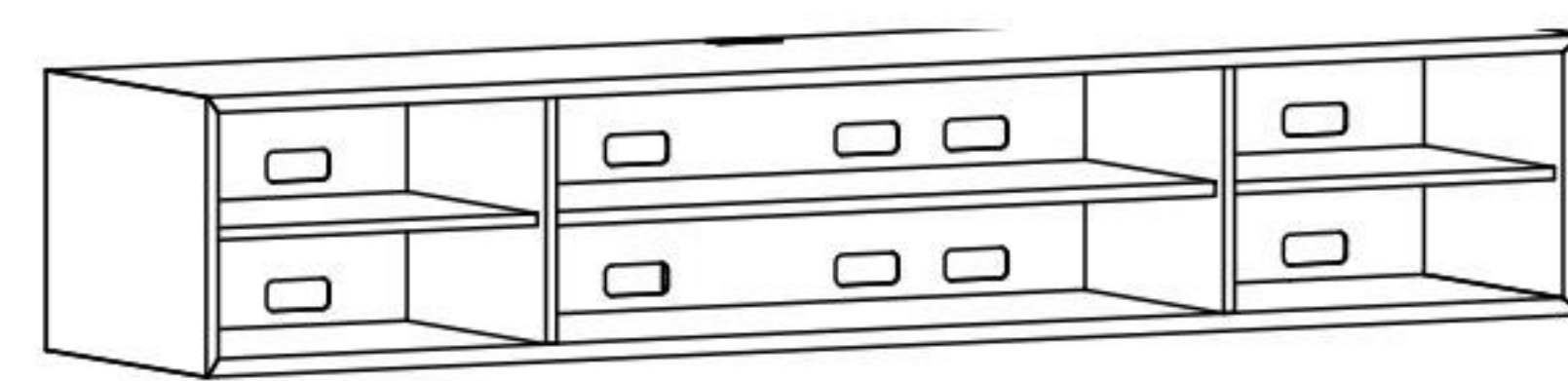

MODEL 241 CENTER

3 rooms · 3 shelves · 3 back plates

Paint: White, lightgrey, grey or black

Veneer: Oak or walnut

Outer measurements: H:366mm, W:2020mm, D:455mm
Inner measurements for each room: H:322mm, W:482mm/980mm*, D:394mm *Measurements when using model 241 Center as a soundbar/center solution

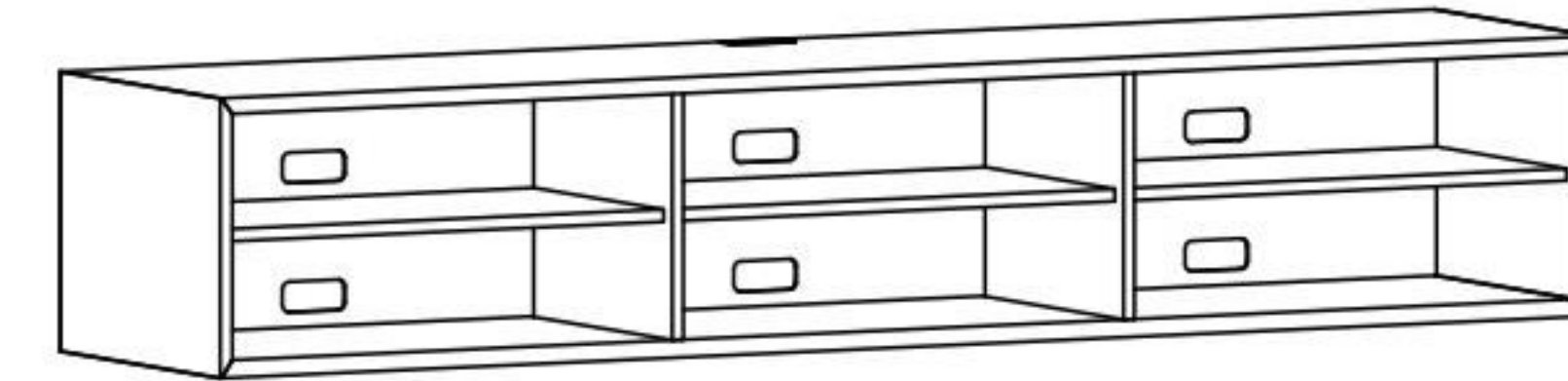

MODEL 241 LARGE

3 rooms · 3 shelves · 3 back plates

Paint: White, lightgrey, grey or black

Veneer: Oak or walnut

Outer measurements: H:366mm, W:2020mm, D:455mm
Inner measurements for each room: H:322mm, W:648mm, D:394mm

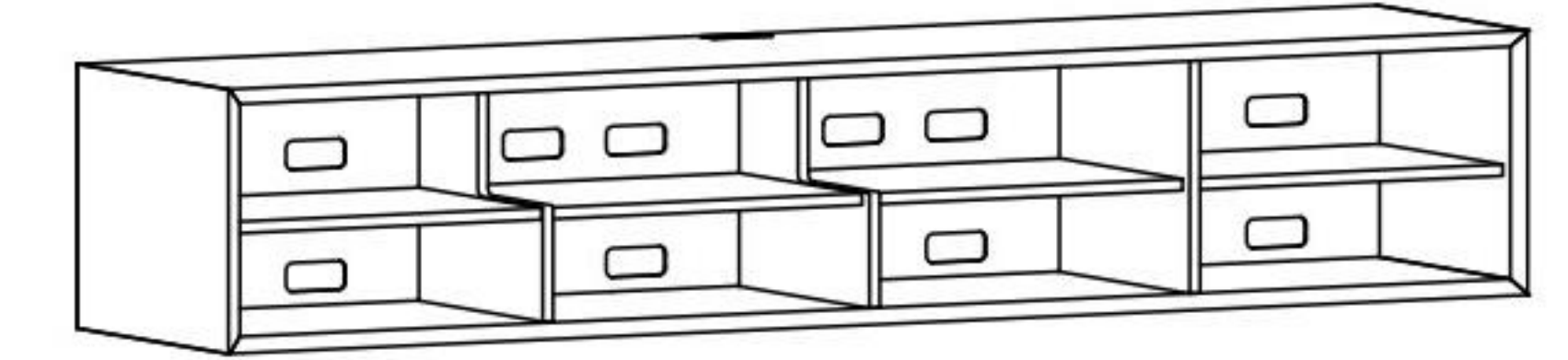

MODEL 241S LEFT

2 rooms · 4 shelves · 4 back plates

Paint: White, lightgrey, grey or black

Veneer: Oak or walnut

Outer measurements: H:366mm, W:2020mm, D:455mm
Inner measurements for each room: H:322mm/162mm*, W:1478mm*/482mm, D:394mm *Measurements when using the top shelf as a soundbar solution

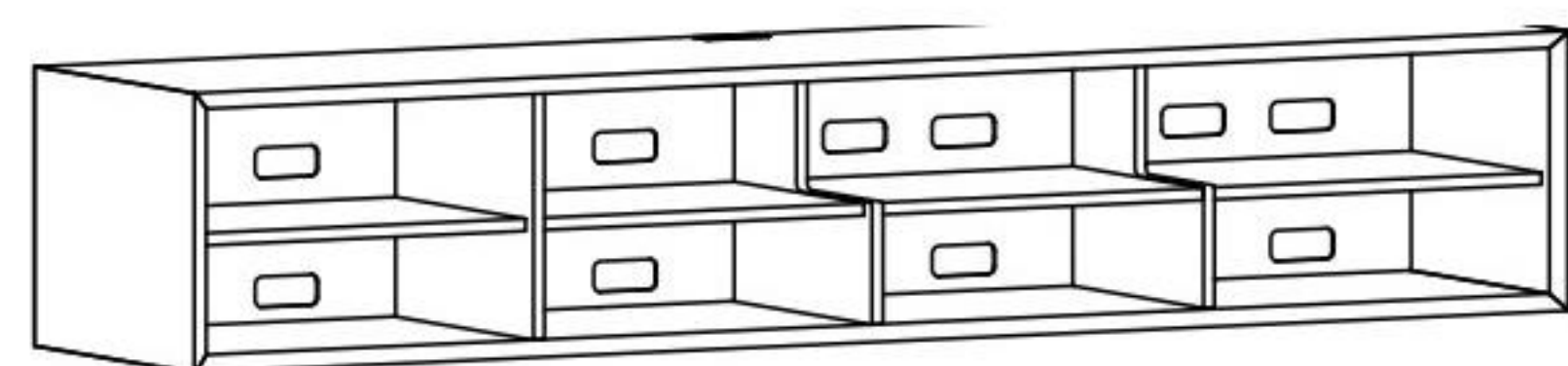

MODEL 241S RIGHT

2 rooms · 4 shelves · 4 back plates

Paint: White, lightgrey, grey or black

Veneer: Oak or walnut

Outer measurements: H:366mm, W:2020mm, D:455mm
Inner measurements for each room: H:322mm/162mm*, W:1478mm*/482mm, D:394mm *Measurements when using the top shelf as a soundbar solution

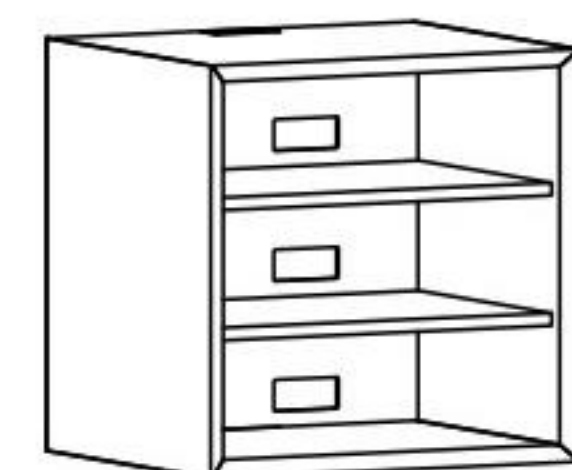

MODEL 311

1 room · 2 shelves · 1 back plate

Paint: White, lightgrey, grey or black

Veneer: Oak or walnut

Outer measurements: H:526mm, W:526mm, D:455mm
Inner measurements: H:482mm, W:482mm, D:394mm



MODEL 311 LARGE

1 room · 2 shelves · 1 back plate

Paint: White, lightgrey, grey or black

Veneer: Oak or walnut

Outer measurements: H:526mm, W:692mm, D:455mm
Inner measurements: H:482mm, W:648mm, D:394mm

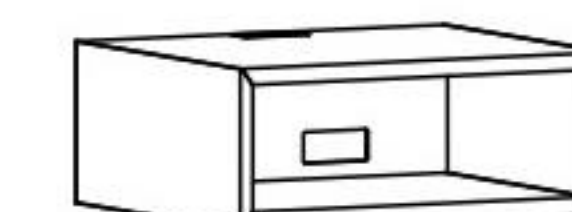

MODEL 111

1 room · 1 back plate

Paint: White, lightgrey, grey or black

Veneer: Oak or walnut

Outer measurements: H:205mm, W:526mm, D:455mm
Inner measurements: H:162mm, W:482mm, D:394mm

DEPTH 55 CM

All clic models have one cable hole center in the top plate. If you want your clic furniture without holes or with extra holes remember to add this information on your order.

When removing the back plate the internal depth is 538mm

Find further measurements on clic.dk

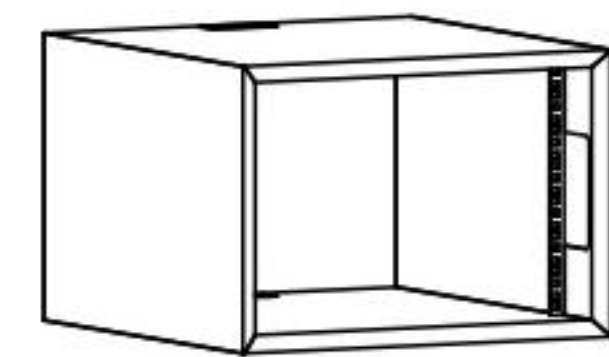

MODEL 212AV
1 room · 19" rack mounts

Paint: White, lightgrey, grey or black
Veneer: Oak or walnut

Outer measurements: H:366mm, W:526mm, D:550mm
Inner measurements: H:322mm, W:482mm, D:465mm

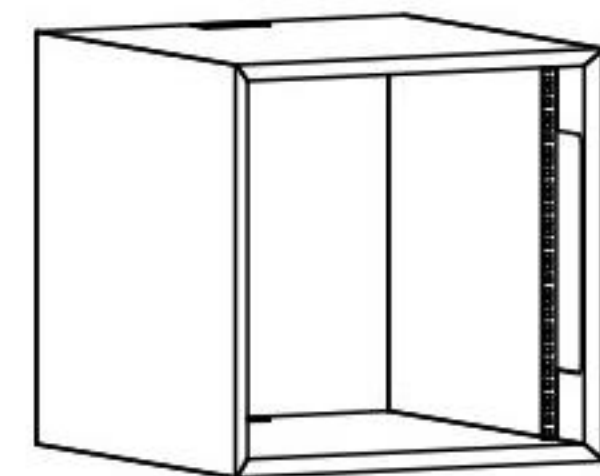

MODEL 312AV
1 room · 19" rack mounts

Paint: White, lightgrey, grey or black
Veneer: Oak or walnut

Outer measurements: H:526mm, W:526mm, D:550mm
Inner measurements: H:482mm, W:482mm, D:465mm

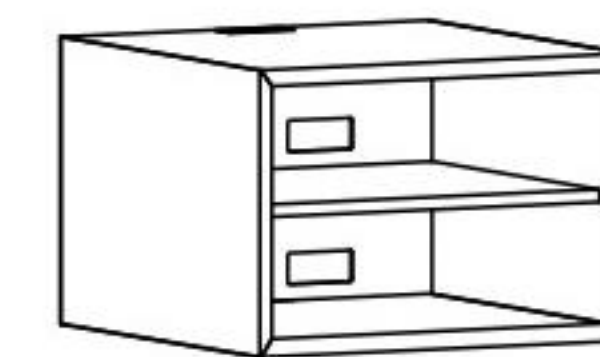

MODEL 212
1 room · 1 shelf · 1 back plate

Paint: White, lightgrey, grey or black
Veneer: Oak or walnut

Outer measurements: H:366mm, W:526mm, D:550mm
Inner measurements: H:322mm, W:482mm, D:489mm



MODEL 212LARGE
1 room · 1 shelf · 1 back plate

Paint: White, lightgrey, grey or black
Veneer: Oak or walnut

Outer measurements: H:366mm, W:692mm, D:550mm
Inner measurements: H:322mm, W:648mm, D:489mm

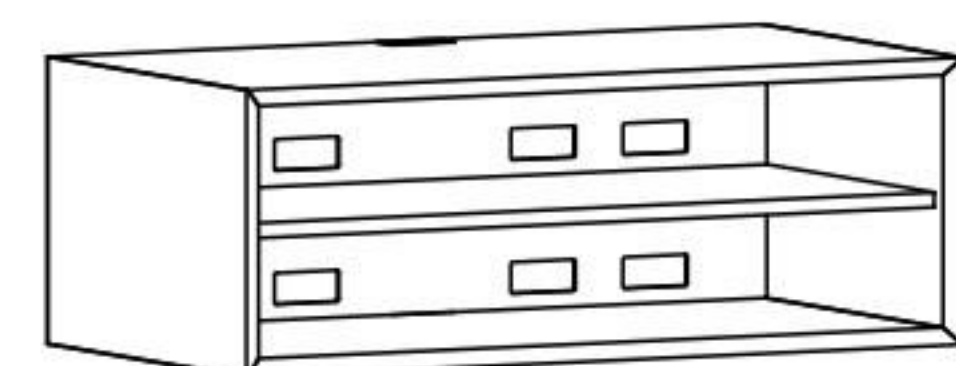

MODEL 222 CENTER
1 room · 1 shelf · 1 back plate

Paint: White, lightgrey, grey or black
Veneer: Oak or walnut

Outer measurements: H:366mm, W:1024mm, D:550mm
Inner measurements: H:322mm, W:980mm, D:489mm

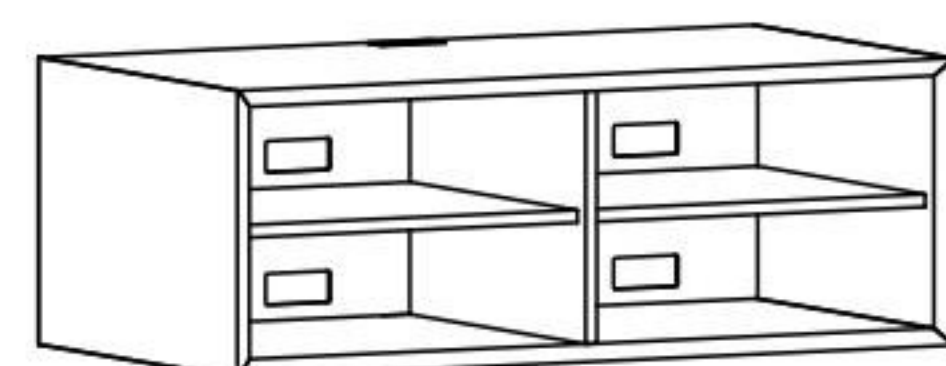

MODEL 222-2
2 rooms · 2 shelves · 2 back plates

Paint: White, lightgrey, grey or black
Veneer: Oak or walnut

Outer measurements: H:366mm, W:1024mm, D:550mm
Inner measurements for each room: H:322mm, W:482mm, D:489mm

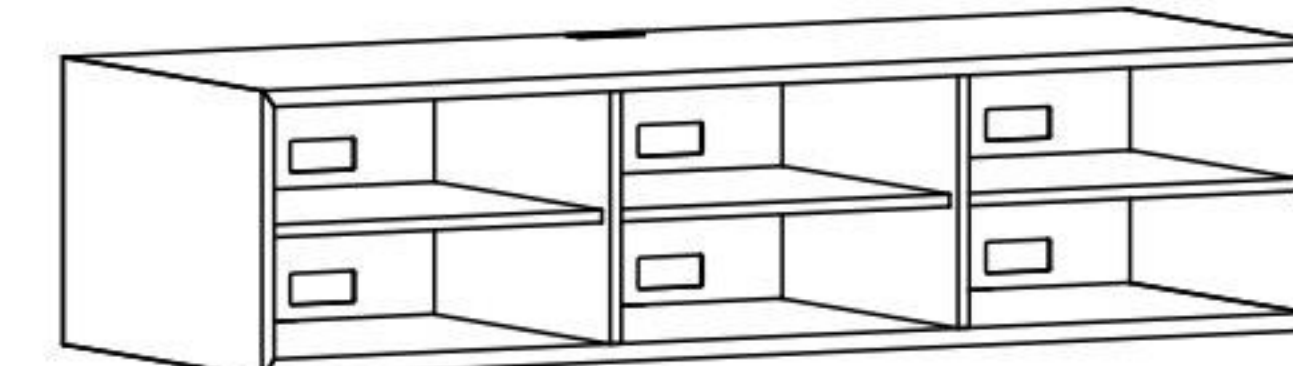

MODEL 232
3 rooms · 3 shelves · 3 back plates

Paint: White, lightgrey, grey or black
Veneer: Oak or walnut

Outer measurements: H:366mm, W:1522mm, D:550mm
Inner measurements for each room: H:322mm, W:482mm, D:489mm

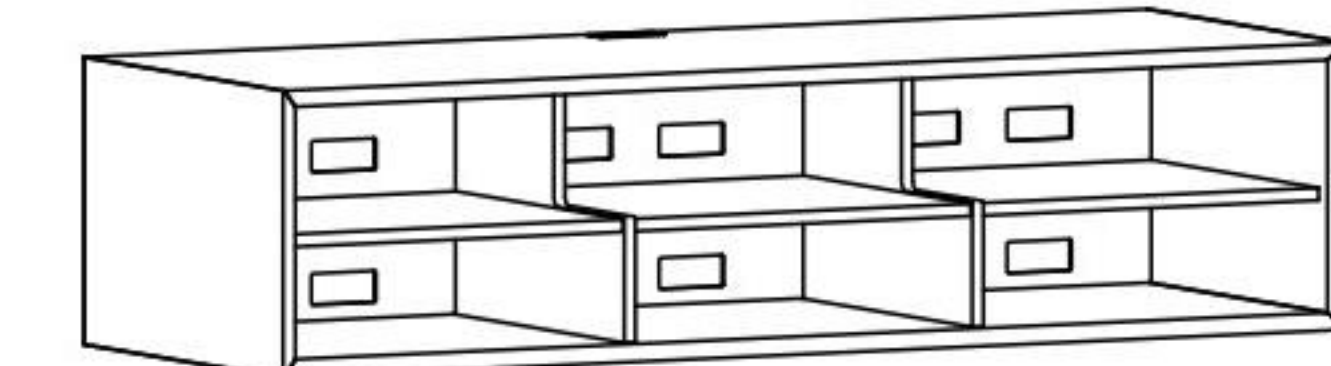

MODEL 232S
1 room · 3 shelves · 3 back plates

Paint: White, lightgrey, grey or black
Veneer: Oak or walnut

Outer measurements: H:366mm, W:1522mm, D:550mm
Inner measurements for each room: H:322mm/162mm*, W:1478mm*/482mm, D:489mm *Measurements when using the top shelf as a soundbar solution

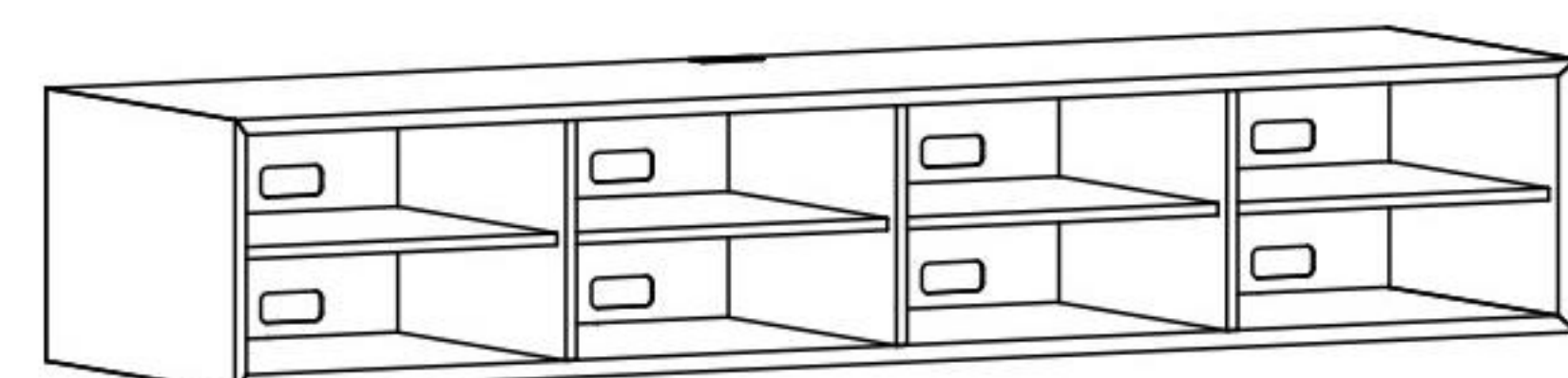

MODEL 242
4 rooms · 4 shelves · 4 back plates

Paint: White, lightgrey, grey or black
Veneer: Oak or walnut

Outer measurements: H:366mm, W:2020mm, D:550mm
Inner measurements for each room: H:322mm, W:482mm, D:489mm

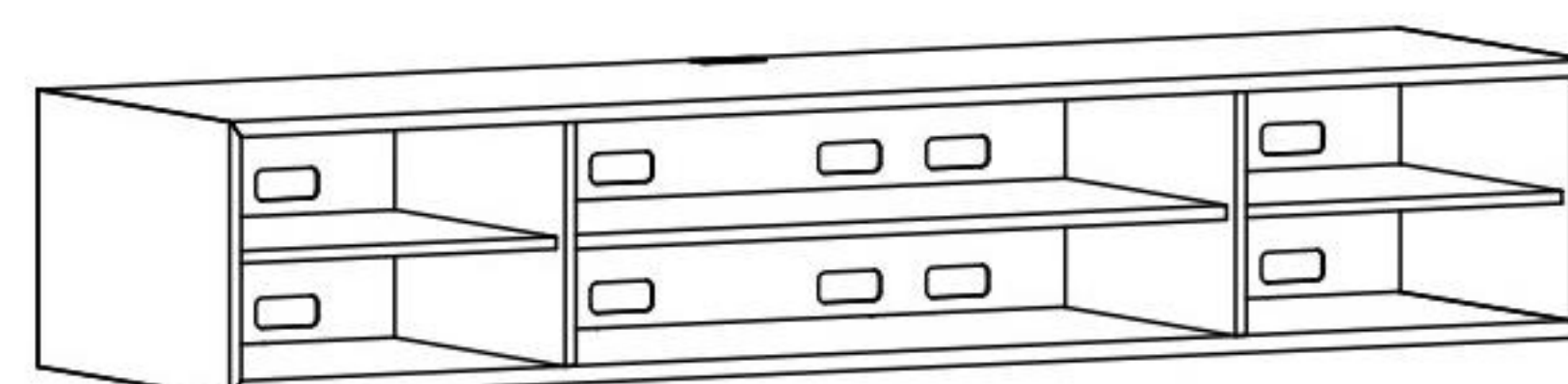

MODEL 242 CENTER
3 rooms · 3 shelves · 3 back plates

Paint: White, lightgrey, grey or black
Veneer: Oak or walnut

Outer measurements: H:366mm, W:2020mm, D:550mm
Inner measurements for each room: H:322mm, W:482mm/980mm*, D:489mm *Measurements when using model 242 Center as a soundbar/center solution

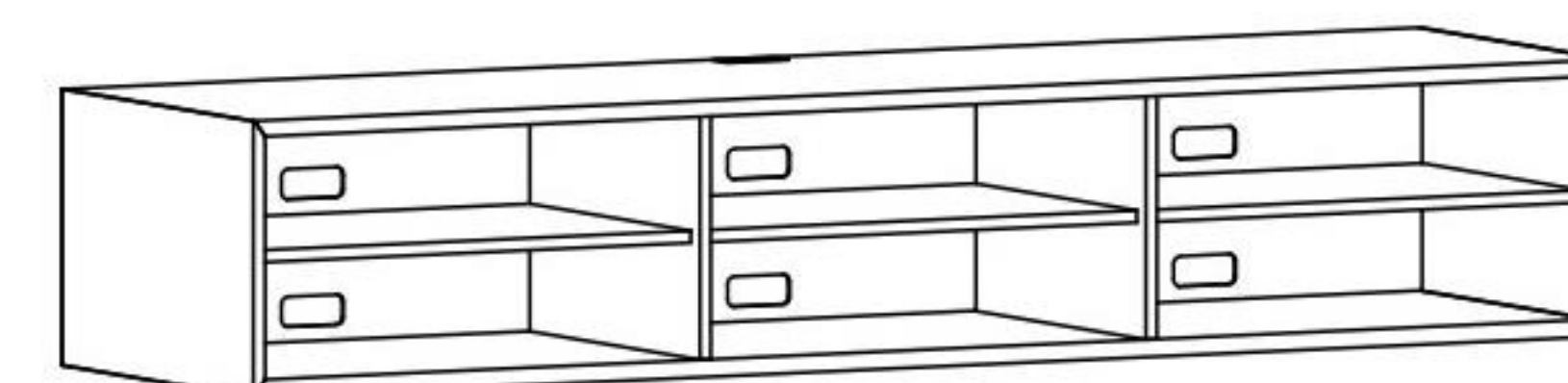

MODEL 242 LARGE
3 rooms · 3 shelves · 3 back plates

Paint: White, lightgrey, grey or black
Veneer: Oak or walnut

Outer measurements: H:366mm, W:2020mm, D:550mm
Inner measurements for each room: H:322mm, W:648mm, D:489mm

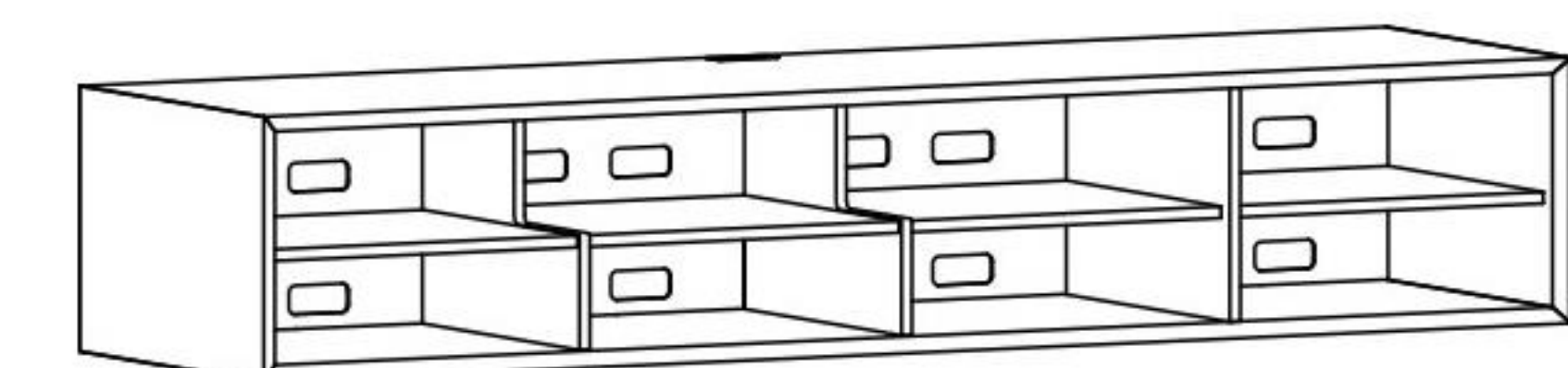

MODEL 242S LEFT
2 rooms · 4 shelves · 4 back plates

Paint: White, lightgrey, grey or black
Veneer: Oak or walnut

Outer measurements: H:366mm, W:2020mm, D:550mm
Inner measurements for each room: H:322mm/162mm*, W:1478mm*/482mm, D:489mm *Measurements when using the top shelf as a soundbar solution



Model 222, 2 pcs

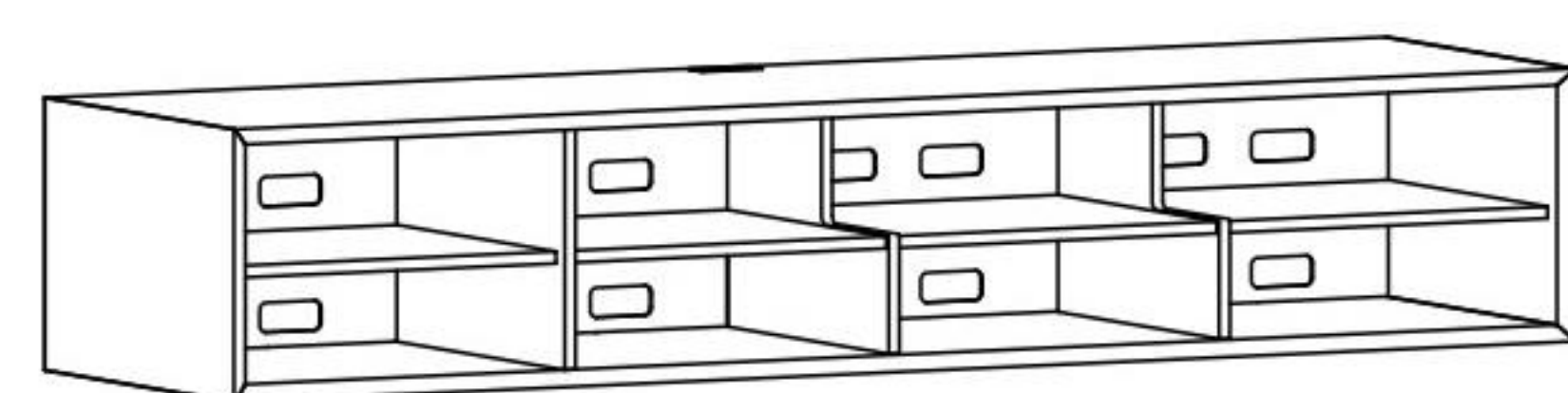

MODEL 242S RIGHT

2 rooms · 4 shelves · 4 back plates

Paint: White, lightgrey, grey or black

Veneer: Oak or walnut

Outer measurements: H:366mm, W:2020mm, D:550mm
 Inner measurements for each room: H:322mm/162mm*,
 W:1478mm*/482mm, D:489mm *Measurements when using the
 top shelf as a soundbar solution

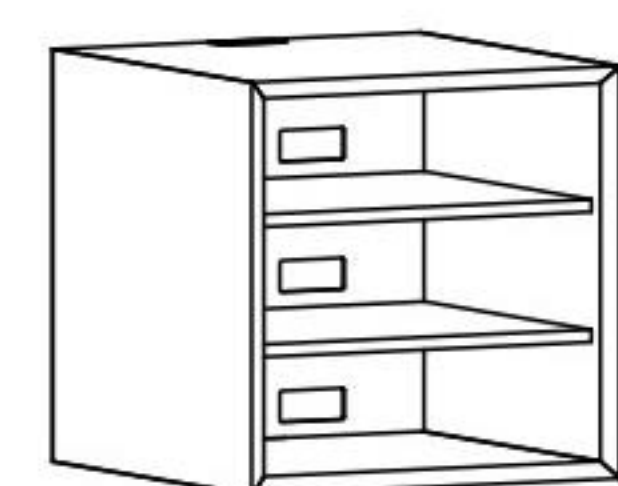

MODEL 312

1 room · 2 shelves · 1 back plate

Paint: White, lightgrey, grey or black

Veneer: Oak or walnut

Outer measurements: H:526mm, W:526mm, D:550mm
 Inner measurements: H:482mm, W:482mm, D:489mm



MODEL 312 LARGE

1 room · 2 shelves · 1 back plate

Paint: White, lightgrey, grey or black

Veneer: Oak or walnut

Outer measurements: H:526mm, W:692mm, D:550mm
 Inner measurements: H:482mm, W:648mm, D:489mm

DOORS & DRAWERS



WOOD DOORS

Paint: White, lightgrey, grey or black
Veneer: Oak or walnut

FABRIC DOORS

16 colours – see page 6

DRAWERS

Paint: White, lightgrey, grey or black
Veneer: Oak or walnut

Depth 26,5 cm: Can't be fitted with drawers
Depth 37,5 cm: Usable space behind drawers 48mm
Depth 45,5 cm: Usable space behind drawers 80mm
Depth 55 cm: Usable space behind drawers 172mm

PROJECTOR DRAWER

Paint: White, lightgrey, grey or black
Veneer: Oak or walnut

For model 210 Large, 240 Large and 310 Large

ACCESSORIES

WALL BRACKET 1

For model 110, 111, 210, 210 Large, 211, 211 Large, 212, 212 Large, 212AV, 310, 310 Large, 311, 311 Large, 312, 312 Large, 312AV, 220 Center, 221 Center, 222 Center, 410

WALL BRACKET 2

For model 12S, 120, 120S, 121, 121S, Desktop, 220-2, 221-2, 222-2, 420

WALL BRACKET 3

For model 13S, 130, 130S, 131, 131S, 230, 230S, 231, 231S, 232, 232S, 430

WALL BRACKET 4

For model 14S Left, 14S Right, 140, 140 Center, 140S Left, 140S Right, 141, 141 Center, 141S Left, 141S Right, 240, 240 Center, 240 Large, 240S Left, 240S Right, 241, 241 Center, 241 Large, 241S Left, 241S Right, 242, 242 Center, 242 Large, 242S Left, 242S Right

WHEELS

Available in white and black. Height: 8cm, diameter 6,5 cm

Use 7 wheels for model 140, 140 Center, 140S Left, 140S Right, 240, 240 Center, 240 Large, 240S Left, 240S Right, 141, 141 Center, 141S Left, 141S Right, 241, 241 Center, 241 Large, 241S Left, 241S Right, 242, 242 Center, 242 Large, 242S Left, 242S Right

Use 6 wheels for model 130, 130S, 131, 131S, 230, 230S, 231, 231S, 232, 232S

Use 5 wheels for model 120, 120S, 121, 121S, 210 Large, 211 Large, 212 Large, 220 Center, 221 Center, 222 Center, 220-2, 221-2, 222-2, 310 Large, 311 Large, 312 Large

Use 4 wheels for model 110, 111, 210, 211, 212, 212AV, 310, 311, 312, 312AV

*Model 12S, 13S, 14S Left, 14S Right, 410, 420 and 430 can't be mounted on wheels

ALU STANDS 1

4 pcs aluminum stands height 3 cm

Available in silver or black

ALU STANDS 2

4 pcs aluminum stands height 19 cm

Available in silver or black

ALU STANDS 3

2 pcs aluminum frames height 19 cm

Depth 37,5 cm, depth 45,5 cm & depth 55 cm

Available in silver or black

ALU STANDS 2 & 3 SUPPORT BAR

2 room furniture, 3 room furniture and 4 room furniture

Available in black steel

MAGNET FEET

Required when stacking the furniture on top of each other

Available in silver or black

Use 4 pcs for 1 room furniture

Use 6 pcs for 2 room furniture

Use 8 pcs for 3 room furniture

Use 10 pcs for 4 room furniture

CABLE COVER PLATE

05a, 05b, 05c or 05d

Available as open, closed, TV on table top stand or for cable tray

Available in silver, black or brass

CABLE TRAYS

Available in white, black and silver

Length 15, 20 or 25 cm

CHARGER FOR iPhone

click alu cover with built-in charger for iPhone 6, 6S, 7 og 8

VENTILATION

Be aware that our ventilation can only be placed in a cable hole that is not placed above a vertical beam in the furniture

VINYL HOLE

The vinyl hole can't be ordered for furniture in 26,5 cm depth, model 220 Center, 221 center, 222 Center, Desktop and all S models

FIREPLACE

The fireplace can't be ordered for furniture in 26,5 cm depth, model 220 Center, 221 Center, 222 Center, Desktop and all S models

IPad POND

iPad pond can't be ordered for a furniture in 26,5 cm depth

SUB HOLE

Lyngdorf BW-2 sub

Sub hul 8"

Sub hul 10"

SUPPORT BARS (PAIR)

For model 220 Center, 221 Center, 222 Center

Required to maintain the form of the furniture when a heavy object is placed on top or inside the furniture.

Available in black or white

SHELVES

Paint: White, lightgrey, grey or black

Veneer: Oak or walnut

BACK PLATES

With or without cable holes

White or black

PLASTIC SHEET

Use when storing binders to avoid scratches



Model 141S Right

-  facebook.com/clicfurniture
-  pinterest.com/clicfurniture
-  twitter.com/clicfurniture
-  instagram.com/clicfurniture

clic
denmark
tel.: +45 8699 7400
info@clic.dk
clic.dk

May be subject to change without notice - E&OE andyou.dk